

SERVICE MANUAL RA-3A CHASSIS

<u>MODEL</u>	<u>COMMANDER</u>	<u>DEST.</u>	<u>CHASSIS NO.</u>	<u>MODEL</u>	<u>COMMANDER</u>	<u>DEST.</u>	<u>CHASSIS NO.</u>
KP-43T75A	RM-Y906	Argentina	SCC-P24A-A				
KP-53SV75A	RM-Y906	Argentina	SCC-P24B-A				

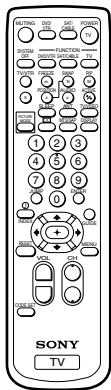

RM-Y906

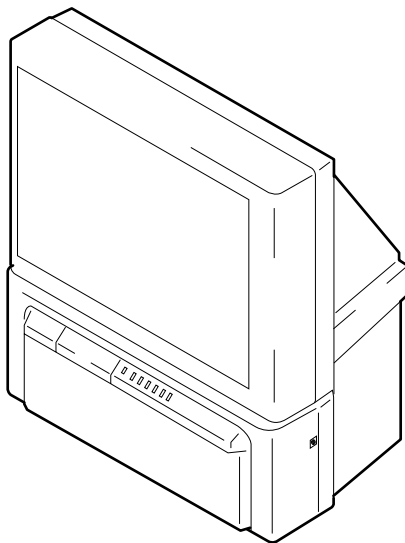

KP-43T75A

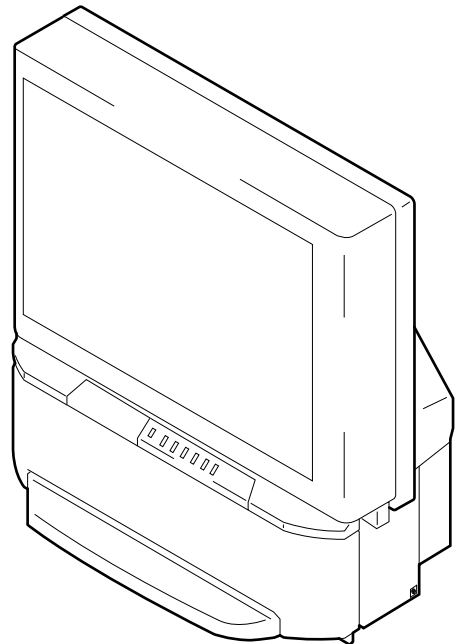

KP-53SV75A

* Please file according to model size.

43 53

COLOR REAR VIDEO PROJECTOR
SONY®

SPECIFICATIONS

Projection system

3 picture tubes, 3 lenses, horizontal in-line system

Picture tube

7-inch high-brightness monochrome tubes (6.3 raster size),
with optical coupling and liquid cooling system

Projection lenses

High performance, large diameter hybrid lens F1.05

Television system

PAL - N, PAL - M, NTSC

Channel coverage

VHF: 2-13/UHF: 14-69/CATV: 1-125

Antenna

75 ohm external terminal for VHF/UHF

Screen size (measured diagonally)

43 inches (KP-43T75A)

53 inches (KP-53SV75A)

Inputs/outputs

VIDEO 1 IN

VIDEO 2 INPUT

S VIDEO IN (4-pin mini DIN):

Y: 1 Vp-p, 75-ohms unbalanced, sync negative

C: 0.286 Vp-p (Burst signal), 75 ohms

VIDEO (phono jack): 1 Vp-p, 75-ohms unbalanced,
sync negative

AUDIO (phono jacks): 500 mVrms (100% modulation),
Impedance: 47 kilohms

VIDEO 3 IN

S VIDEO IN (4-pin mini DIN):

Y: 1 Vp-p, 75-ohms unbalanced, sync negative

C: 0.286 Vp-p (Burst signal), 75 ohms

VIDEO (phono jack): 1 Vp-p, 75-ohms unbalanced,
sync negative

Y: 1 Vp-p, 75 ohms, sync negative

Pb: 0.7 Vp-p, 75 ohms

Pr: 0.7 Vp-p, 75 ohms

AUDIO (phono jacks): 500 mVrms (100% modulation),
Impedance: 47 kilohms

MONITOR OUT

VIDEO (phono jack): 1 Vp-p, 75-ohms unbalanced,
sync negative

AUDIO (phono jacks): 500 mVrms (100% modulation),
Impedance: 470 ohms

AUDIO (VAR/FIX) OUT (phono jacks): 500 mVrms
(100% modulation), Impedance: 470 ohms

CONTROL S OUT: minijack

Speaker

66 mm (2 5/8") × 2, 160 mm (6 3/8") × 2 (KP-53SV75A)

100 mm (4") × 2 (KP-43T75A)

Speaker output

17W × 2

Power requirement

110-220 V AC, 50/60 Hz

Power consumption

In use (Max.): 160 W

In standby: 1 W

Dimensions (W/H/D)

965 × 1,058 × 510 mm (38 × 41 5/8 × 20 1/8 inches)

(KP-43T75A)

1,216 × 1,417 × 632 mm (47 7/8 × 55 3/4 × 24 7/8 inches)

(KP-53SV75A)

Mass

65 kg (143 lbs 5 oz) (KP-43T75A)

77 kg (169 lbs 12 oz) (KP-53SV75A)

Supplied accessories

Remote control RM-Y906 (1)

Batteries (2) size AA (R6)

Optional accessories

Connecting cables

RK-G34, RK-74A, RK-G69HG, VMC-10HG,

VMC-720M, VMC-810S/820S, YC-15V/30V

U/V mixer EAC-66

Design and specifications are subject to change without notice.

SELF DIAGNOSIS FUNCTION

1. Summary of Self-Diagnosis Function

- This device includes a self-diagnosis function.
- In case of abnormalities, the TIMER/STANDBY indicator automatically blinks. It is possible to predict the abnormality location by the number of blinks. The Instruction Manual describes blinking of the TIMER/STANDBY indicator.
- If the symptom is not reproduced sometimes in case of a malfunction, there is recording of whether a malfunction was generated or not. Operate the remote command to confirm the matter on the screen and to predict the location of the abnormality.

2. Diagnosis Items and Prediction of Malfunction Location

- When a malfunction occurs the TIMER/STANDBY indicator only blinks for one of the following diagnosis items. In case of two or more malfunctions, the item which first occurred blinks. If the malfunctions occurred simultaneously, the item with the lower blink count blinks first.
- The screen display displays the results regarding all the diagnosis items listed below. The display “ 0 ” means that no malfunctions occurred.

Diagnosis item	TIMER/STANDBY Indicator Number of blinks	Supposed malfunction	Condition	Self-diagnosis screen display, Diagnosis item: Results
• Power not ON	0	[Standby Power Supply System] F601 open. R607 open. Q601 short circuit [Main Power Supply System] IC601 and R612 are broken. VDR601 short-circuit	Cannot turn on the power. LED doesn't blink.	
+B OCP detection	2 times	Short circuit of power supply system in each circuit.	Goes to the standby mode Short circuit of +B line	2 : +B OCP 000
+B OVP detection	3 times	T603 pin 78 open. R672 open.	Goes to the standby mode Malfunction of power supply circuit	3 : +B OVP 000
Vertical deflection stop	4 times	IC1509(V out) is broken. Q1505(V Pulse Buffer) is broken.	Raster goes to one line horizontally, Aand then video signal is muted.	4 : V Stop 000
Video out abnormality detection	5 times	Video out, Q705, 732, 761 and others in C board circuit. Q218, 219, 220 (A board)	TIMER/STANDBY LED blinks approx. 30 seconds, and then blinks for the self diagnosis.	5 : AKB 000
Horizontal deflection stop	6 times	C515, 516 open. IC206(YC Jungle) is broken.	Raster doesn't appear.	6 : H Stop 000
Audio abnormality detection	8 times	IC406(Audio amp.) is broken. PS401, 402 open.	The sound is not out. Goes to the standby mode	8 : Audio 000

* : 000 the range of values for number of operations is 000-255. For 256 or higher there is no count up and the number remains at 255.

3. Blinking count display of TIMER/STAVDBY indicator

* One blink is not used for self-diagnosis.

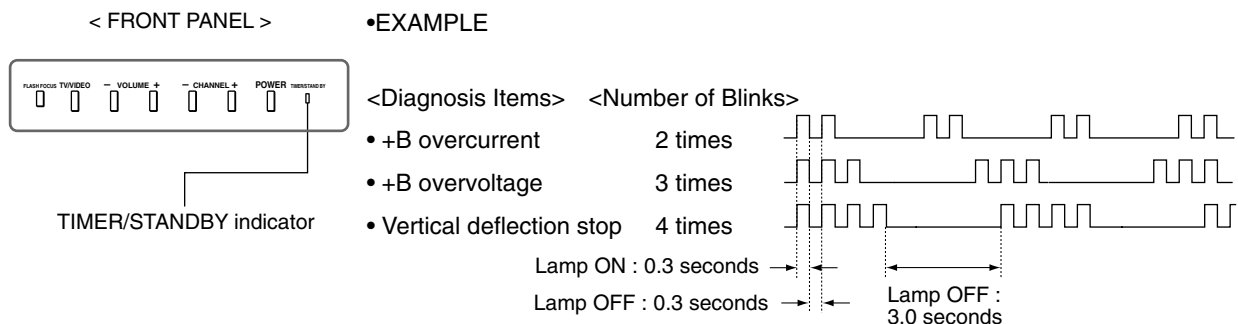

Release of TIMER/STANDBY indicator blinking.

- The TIMER/STANDBY indicator blinking display is released by turning OFF the power switch on the TV main unit or removing the plug from the power.

4. Self-diagnosis screen displays

- In cases of malfunctions where it is not possible to determine the symptom such as when the power goes off occasionally or when the screen disappears occasionally, there is a screen display on whether the malfunction occurred or not in the past (and whether the detection circuit operated or not) in order to allow confirmation.

<Screen Display Method>

- Quickly press the remote command button in the following order from the standby state.

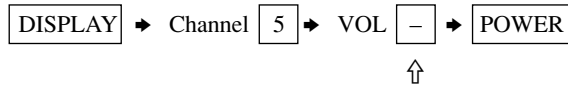

Be aware that this differs from the method of entering the service mode (volume +).

Self-diagnosis screen display

Self Check		
2 : +B	OCP	000
3 : +B	OVP	000
4 : V	Stop	000
5 : AKB		000
6 : H	Stop	000
7 : HV		000
8 : Audio		000
101 : WDT		000

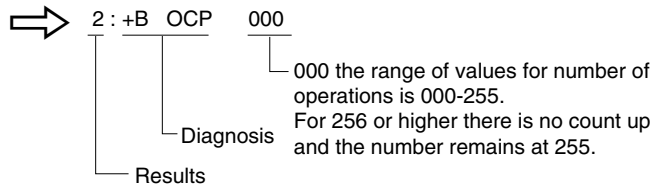

5. Self-Diagnosis Screen Display

- The results display is not automatically cleared. In case of repairs and after repairs, check the self-diagnosis screen and be sure to return the results display to “0”.
- If the results display is not returned to “0” it will not be possible to judge a new malfunction after completing repairs.

<Method of Clearing Results Display>

- Power off (Set to the standby mode)
- DISPLAY → Channel 5 → VOL + → POWER (Service Mode)
- Channel 8 → ENTER (Test reset = Factory preset condition)

<Method of Ending Self Diagnosis Screen>

- When ending the self-diagnosis screen completely, turn the power switch OFF on the remote commander or the main unit.

6. Self-diagnosis function operation

- OCP** Low B and +B line detect DET SHORT, and shut-down POWER ON RELAY.
Reset by turning power on/off.
In case of +B is loaded approx. 1.3A or more, microcomputer detects it via IC651.
- OVP** In case of +B becomes approx. 150V or more, POWER ON RELAY shuts down and microcomputer detects it via IC651.
Reset by turning power on/off just the same as OCP.
- V Stop** In case of microcomputer detects 2 seconds or more interval of V Pulse, Reference Pulse turns off by turning off the picture signal in YC Jungle IC (IC206).
After the picture signal turns off, V Pulse is regenerated 2 seconds or more, the picture signal turns on.
- AKB** IK detection. Makes LED blinking in case of microcomputer doesn't detect IK returns of IC206 CXA2135 30 seconds or more.
- H Stop** In case of HV becomes 33kV or more, IC502 detects it and shut-down H Drive Pulse.
Microcomputer receives H Stop data from IC206 and makes LED blinking.
- Audio** In case of DC component overlaps the output of Audio Amp., microcomputer detects it and makes LED blinking.
Microcomputer forces to shut down the power.

Self-diagnosis block diagram

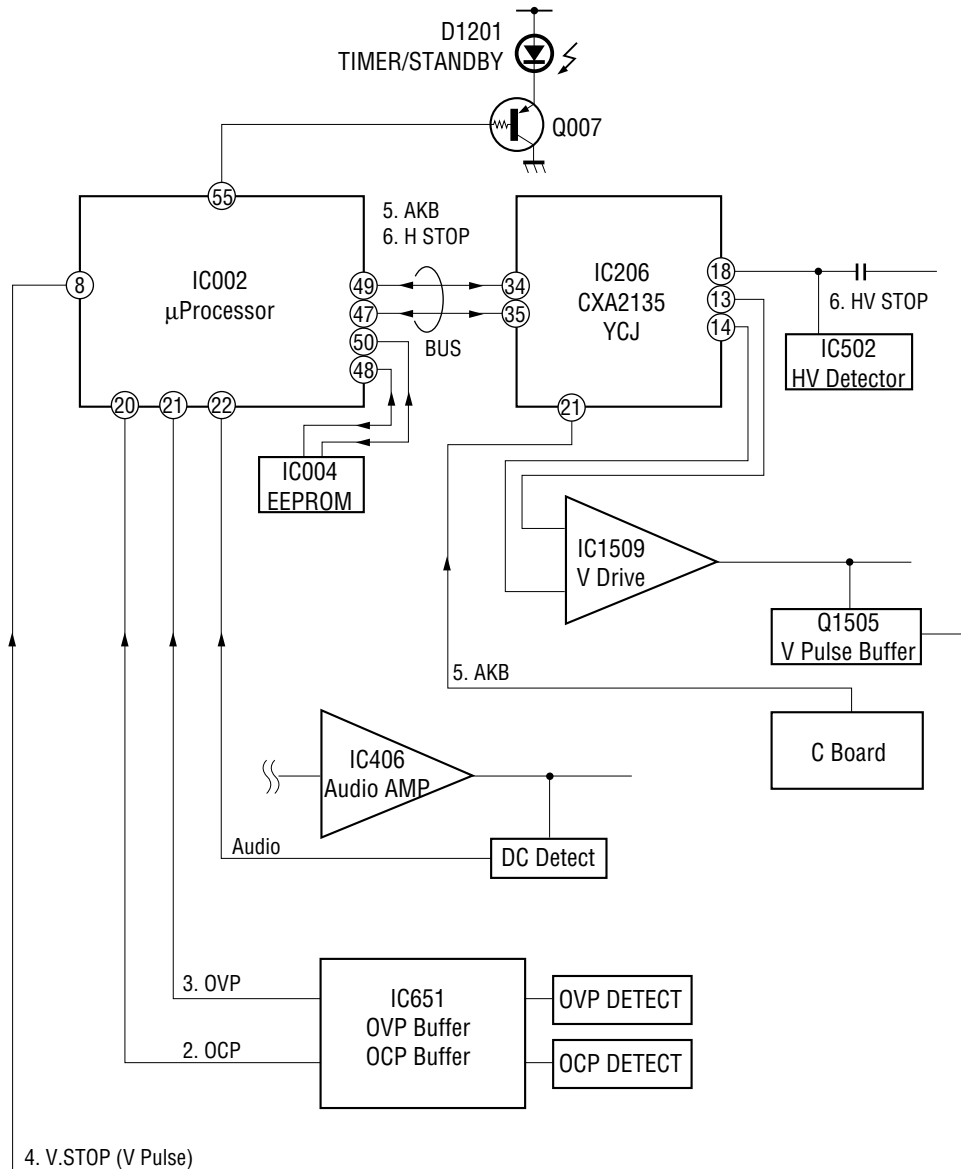

TABLE OF CONTENTS

<u>Section</u>	<u>Title</u>	<u>Page</u>	<u>Section</u>	<u>Title</u>	<u>Page</u>
	SELF DIAGNOSIS FUNCTION	3			
1. GENERAL			5. CIRCUIT ADJUSTMENTS		
Remote Control	7		5-1. TV Input Sub Contrast Adjustment (VPTR-GDRV)	41	
Precautions	8		5-2. TV Input Sub-HUE and Sub-Color Adjustment (VPTR-SHUE, SCOL)	41	
Installing and Connecting the Projection TV	8		5-3. PIP Sub Contrast Adjustment (SC-SYDR)	41	
Basic Set Up	12		5-4. PIP Sub-HUE, Sub-Color Adjustment (SC-PHDR, SSCL)	41	
Using Your New Projection TV	14		5-5. Bar Display Position Adjustment (OP-DISP)	42	
Adjusting Your SET UP (menus)	16		5-6. PIP Position Adjustment (PI-PIPH, PIPV, PPH5, PPV5)	42	
Operating Video Equipment	22		5-7. TEXT Position Adjustment (CCD-CCHP)	42	
Operating a Cable Box	23				
Troubleshooting	23		6. DIAGRAMS		
2. DISASSEMBLY			6-1. Block Diagram (1)	43	
2-1. Rear Board Removal	25		Block Diagram (2)	45	
2-2. Chassis Assy Removal	25		Block Diagram (3)	51	
2-3. Service Position	25		Block Diagram (4)	55	
2-4. HA Board and HB Board Removal(KP-53SV75A)	25		Block Diagram (5)	58	
2-5. HA,HB and FB Board Removal(KP-43T75A)	26		6-2. Frame Schematic Diagram	61	
2-6. Mirror Cover Removal	26		6-3. Circuit Boards Location	64	
2-7. Beznet Assy and FB Board (KP-53SV75A) Removal	26		6-4. Printed Wiring Boards and Schematic Diagrams	64	
2-8. HC Board and S Board Removal	26		• A (1/3)Board	65	
2-9. A, G and FA Boards Removal	27		• A (2/3)Board	69	
2-10. Picture Tube Removal	27		• A (3/3)Board	73	
2-11. High-Voltage Cable Installation and Removal	27		• G Board	81	
			• CG Board	88	
3. SET-UP ADJUSTMENTS			• CR Board	89	
3-1. Screen Voltage Adjustment (Coarse Adjustment)	28		• CB Board	89	
3-2. Screen (G2) Adjustment (Fine Adjustment)	28		• HA Board	91	
3-3. Deflection York Tilt Adjustment	28		• HC Board	91	
3-4. Focus Lens Adjustment	28		• HB Board	92	
3-5. Focus VR Adjustment	29		• FA Board	93	
3-6. 2-Pole Magnet Adjustment (Green, Red)	29		• FB Board	93	
3-7. 4-Pole Magnet Adjustment	29		6-5. Semiconductors	94	
3-8. Defocus Adjustment (Blue)	29				
3-9. Electrical Adjustment by Remote Commander	30		7. EXPLODED VIEWS		
3-10. Registration Adjustment(PJE)	35		7-1. Cover (KP-43T75A)	96	
3-11. Auto Registration Error Code List	38		7-2. Cover (KP-53SV75A)	97	
4. SAFETY RELATED ADJUSTMENTS			7-3. Chassis (KP-43T75A)	98	
4-1. HV Regulation Circuit Check and Adjustment	39		7-4. Chassis (KP-53SV75A)	99	
4-2. HV Hold Down Circuit Operation and Adjustment ..	39		7-5. Picture Tube	100	
4-3. +B Max Voltage Confirmation	39				
4-4. +B OVP Confirmation	40		8. ELECTRICAL PARTS LIST	101	

(CAUTION)

SHORT CIRCUIT THE ANODE OF THE PICTURE TUBE AND THE ANODE CAP TO THE METAL CHASSIS, CRT SHIELD, OR CARBON PAINTED ON THE CRT, AFTER REMOVING THE ANODE.

WARNING!!

AN ISOLATION TRANSFORMER SHOULD BE USED DURING ANY SERVICE TO AVOID POSSIBLE SHOCK HAZARD, BECAUSE OF LIVE CHASSIS. THE CHASSIS OF THIS RECEIVER IS DIRECTLY CONNECTED TO THE AC POWER LINE.

SAFETY-RELATED COMPONENT WARNING!!

COMPONENTS IDENTIFIED BY SHADING AND MARK \triangle ON THE SCHEMATIC DIAGRAMS, EXPLODED VIEWS AND IN THE PARTS LIST ARE CRITICAL TO SAFE OPERATION. REPLACE THESE COMPONENTS WITH SONY PARTS WHOSE PART NUMBERS APPEAR AS SHOWN IN THIS MANUAL OR IN SUPPLEMENTS PUBLISHED BY SONY. CIRCUIT ADJUSTMENTS THAT ARE CRITICAL TO SAFE OPERATION ARE IDENTIFIED IN THIS MANUAL. FOLLOW THESE PROCEDURES WHENEVER CRITICAL COMPONENTS ARE REPLACED OR IMPROPER OPERATION IS SUSPECTED.

SECTION 1

GENERAL

The operating instructions mentioned here are partial abstracts from the Operating Instructions Manual. The page numbers of the Operating Instruction Manual remain as in the manual. (Part no : 4-076-754-11)

Remote Control

In the instructions that follow, we will refer to the buttons on your remote control. Keep this flap unfolded and use this page for reference.

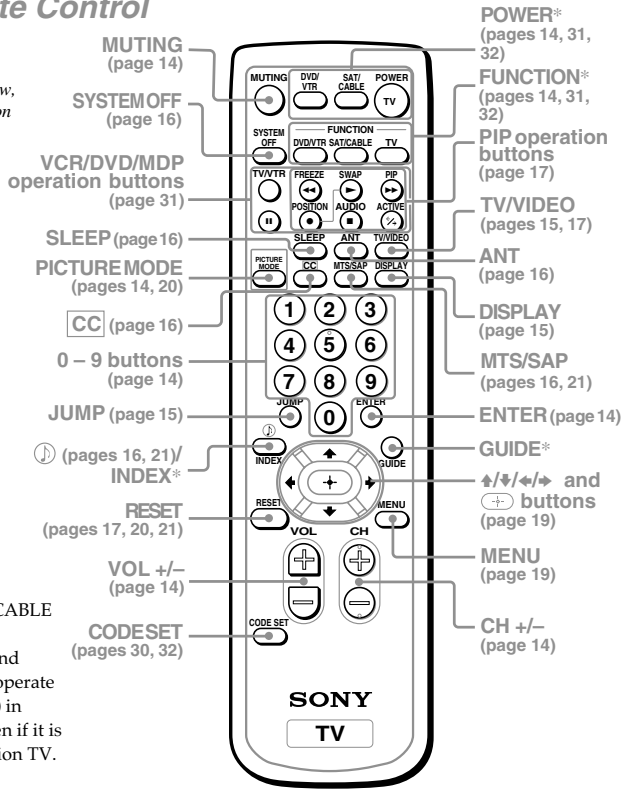
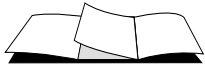

* The blue-labeled SAT/CABLE (POWER), SAT/CABLE (FUNCTION), INDEX and GUIDE buttons cannot operate a satellite receiver (SAT) in Argentine and Chile even if it is connected to the projection TV.

Getting to know the buttons on the remote control

Names of the buttons on the remote control are presented in different colors to represent the available functions.

Button color

- Transparent Press to select the component you want to control; e.g. VTR (VCR)/MDP/DVD Player, CABLE, or projection TV.
- Green Buttons relevant to power operations, like turning the projection TV, CABLE, or VTR (VCR)/MDP/DVD Player on or off

Label color

- White TV/VTR (VCR)/MDP/DVD Player/CABLE operation buttons
- Yellow PIP operation buttons
- Blue SAT operation buttons*
- Green S-Link operation buttons
- Pink DVD Player operation buttons

For a detailed explanation of most buttons, see "Watching the TV" on page 14.

Welcome!

Thank you for purchasing the Sony Color Rear Video Projection TV.

This manual is for models KP-43T75A, KP-43T75C, KP-53SV75A, KP-53SV75C and KP-61SV75C.

Model KP-53SV75A is used for illustration purposes.

The features you will enjoy include:

- FLASH FOCUS, allowing you to adjust convergence automatically.
- Picture-in-Picture (PIP), allowing you to view another TV channel, video or cable image as a window picture.
- Favorite Channel, allowing you to view and choose from eight of your favorite channels
- Y/Pb/Pr inputs for DVD Player connections.
- Three AUDIO/VIDEO/S VIDEO inputs.

Using This Manual

We recommend that you carefully review the contents of the following four sections in the order provided to ensure that you fully understand the operation of your new projection TV.

1 Installing and Connecting the Projection TV

This section guides you through your initial set up. It shows you how to install your projection TV, to connect your new components and to connect to the antenna and cable.

2 Basic Set Up

This section teaches you the basic skills needed to operate your new projection TV, including Auto Set Up. It shows you how to operate the remote control's special functions.

3 Using Your New Projection TV

This section shows you how to begin using your new projection TV. It shows you how to use your remote control's features.

4 Adjusting Your Set Up (menus)

This section teaches you how to access on-screen menus and adjust your projection TV's settings.

Instructions in this manual are written for the remote control. Similar controls may be found on the projection TV console.

Precautions

Safety

- Operate the projection TV only on 110-220 V AC.
- The plug is designed, for safety purposes, to fit into the wall outlet only one way. If you are unable to insert the plug fully into the outlet, contact Sony Authorized Service Center.
- If any liquid or solid object should fall inside the cabinet, unplug the projection TV immediately and have it checked by Sony Authorized Service Center before operating it further.
- If you will not be using the projection TV for several days, disconnect the power by pulling the plug itself. Never pull on the cord.

Note on cleaning

Clean the cabinet of the projection TV with a dry soft cloth. To remove dust from the screen, wipe it gently with a soft cloth. Stubborn stains may be removed with a cloth slightly dampened with solution of mild soap and warm water. Never use strong solvents such as thinner or benzine for cleaning.

If the picture becomes dark after using the projection TV for a long period of time, it may be necessary to clean the inside of the projection TV. Consult qualified service personnel.

Installing

- To prevent internal heat buildup, do not block the ventilation openings.
- Do not install the projection TV in a hot or humid place, or in a place subject to excessive dust or mechanical vibration.
- Avoid operating the projection TV at temperatures below 5° C (41° F).
- If the projection TV is transported directly from a cold to a warm location, or if the room temperature changes suddenly, the picture may be blurred or show poor color. In this case, please wait a few hours to let the moisture evaporate before turning on the projection TV.
- To obtain the best picture, do not expose the screen to direct illumination or direct sunlight. It is recommended to use spot lighting directed down from the ceiling or to cover the windows that face the screen with opaque drapery. It is desirable to install the projection TV in a room where the floor and walls are not of a reflective material.

2

Installing and Connecting the Projection TV

Carrying Your Projection TV

Carrying the projection TV requires three or more people.

For KP-53SV75A/53SV75C/61SV75C

The projection TV has been equipped with casters for easy movement on a hard surface. Please move your projection TV using the casters.

Installing the Projection TV

Recommended viewing area (Horizontal)

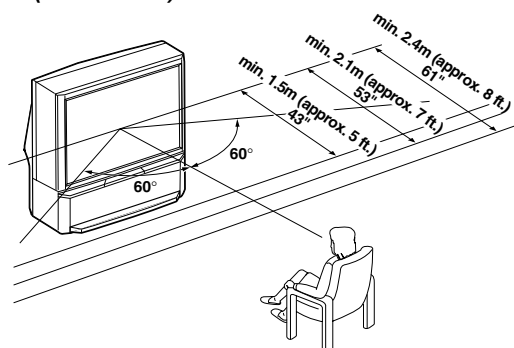

Recommended viewing area (Vertical)

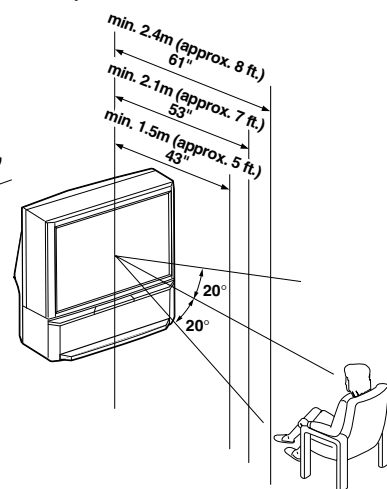

3

■■■ Installing and Connecting the Projection TV (continued)

Connecting a cable TV system/ antenna to a VCR

- 1 Attach the coaxial cable from the incoming cable connection or antenna to VHF/UHF IN on the VCR.
- 2 Using a coaxial cable, connect VHF/UHF OUT on the VCR to VHF/UHF on the projection TV.
- 3 Using AUDIO and S VIDEO* cables, connect AUDIO and S VIDEO OUT on the VCR to AUDIO and S VIDEO IN on the projection TV (White-AUDIO Left, Red-AUDIO Right**).

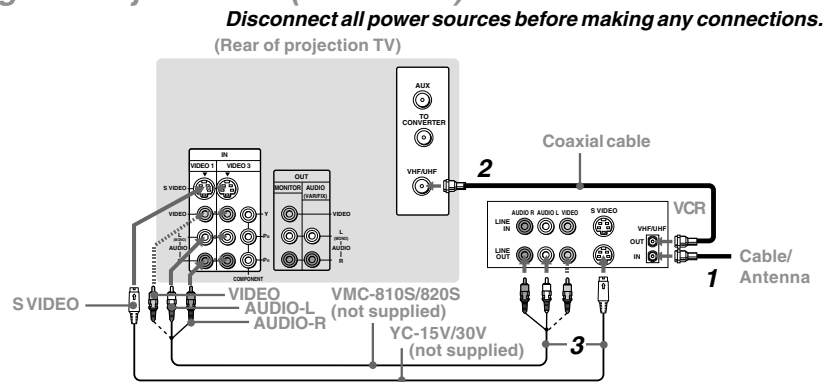

Connecting a VCR and projection TV to a cable box

- 1 Connect the single (input) jack of the splitter to the incoming cable connection, and connect the other two (output) jacks (using the coaxial cable) to IN on the cable box and VHF/UHF on the projection TV.
- 2 Using a coaxial cable, connect OUT on the cable box to VHF/UHF IN on the VCR.
- 3 Using AUDIO and S VIDEO* cables, connect AUDIO and S VIDEO OUT on the VCR to AUDIO and S VIDEO IN on the projection TV (White-AUDIO Left, Red-AUDIO Right**).

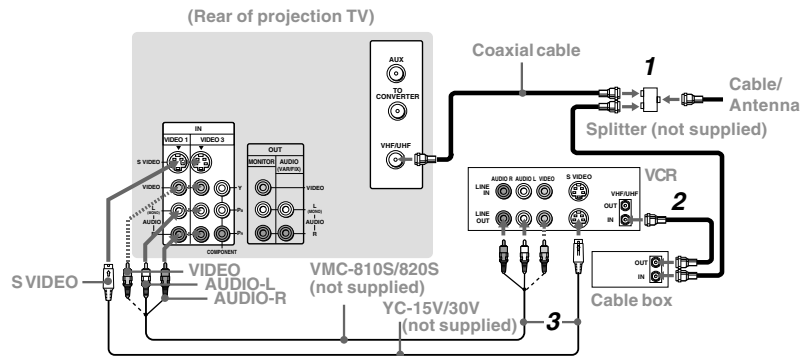

Note:

- To view scrambled channels through the cable box, select the video input which the cable box is connected to by pressing TV/VIDEO.
- * If your VCR is not equipped with S VIDEO, use a VIDEO cable (yellow) instead of the S VIDEO cable.
- ** If you are connecting a monaural VCR, connect only the single audio output to the left (MONO) input on the projection TV.

Connecting a camcorder

Use this connection to view a picture directly from your camcorder.

- 1 Using AUDIO and S VIDEO* cables, connect AUDIO and S VIDEO OUT on the camcorder to AUDIO and S VIDEO IN inside the drop-down panel on the front of the projection TV (White-AUDIO Left, Red-AUDIO Right**).
 - 2 Press VIDEO 2 to select the video inputs from a camcorder.
- * If your camcorder is not equipped with S VIDEO, use a VIDEO cable (yellow) instead of the S VIDEO cable.
** If you are connecting a monaural camcorder, connect only the single audio output to the left (MONO) input on the projection TV.

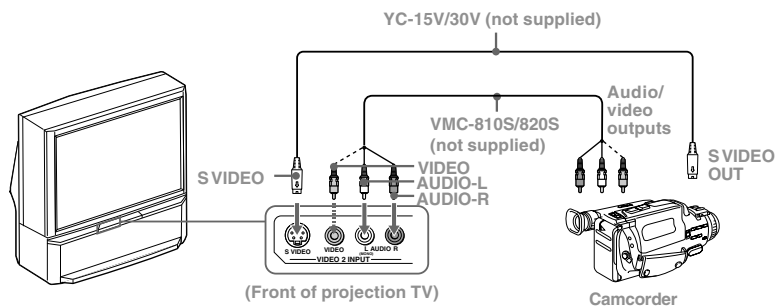

Disconnect all power sources before making any connections.

Installing and Connecting the Projection TV (continued)

Disconnect all power sources before making any connections.

Connecting two VCRs for tape editing

By connecting a second VCR to MONITOR OUT, you can record a program being played by the primary VCR to the second VCR or perform tape editing and dubbing.

- 1 Connect the VCR intended for playback using the connection instructions on page 6 of this manual.
- 2 Using an AUDIO/VIDEO cable, connect AUDIO and VIDEO IN on the VCR intended for recording to AUDIO and VIDEO OUT of MONITOR OUT on the projection TV.

Notes:

- Do not change the input signal while editing through MONITOR OUT.
- When connecting a single VCR to the projection TV: if VCR LINE OUT is connected to VIDEO IN on the projection TV, **do not** connect MONITOR OUT on the projection TV to the VCR LINE INPUT (see right). Doing so will cause program interference and other viewing problems.

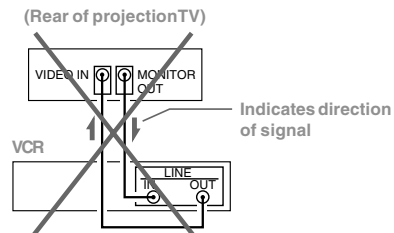
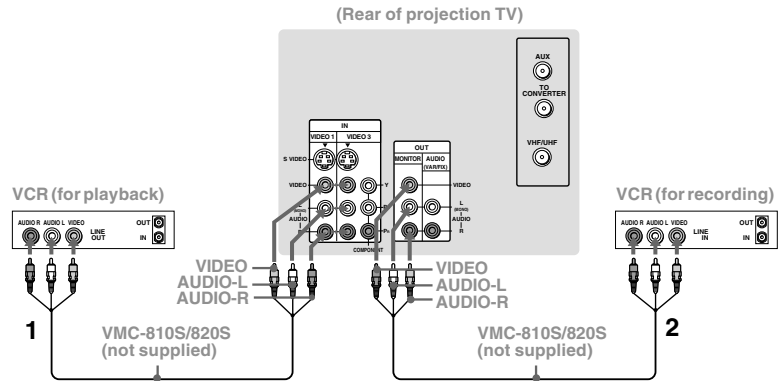

8

Connecting a DVD Player (Upper illustration)

Using an AUDIO and S VIDEO cables, connect AUDIO and S VIDEO IN on the projection TV to AUDIO and S VIDEO OUT on the DVD Player (White-AUDIO Left, Red-AUDIO Right).

Connecting a DVD Player with component video output connectors (Lower illustration)

- 1 Using an AUDIO cable, connect AUDIO of LINE OUT on the DVD Player to AUDIO of VIDEO 3 IN on the projection TV (White-AUDIO Left, Red-AUDIO Right).
- 2 Using three yellow VIDEO cables, connect Y, P_B, and P_R of COMPONENT VIDEO OUT on the DVD Player to Y, P_B, and P_R of VIDEO 3 IN on the projection TV.

Note:

- Some DVD Player terminals may be labeled differently. If so, connect as follows:
Connect Y (green) to Y.
Connect P_B (blue) to C_B, C_b or B-Y.
Connect P_R (red) to C_R, C_r or R-Y.

Disconnect all power sources before making any connections.

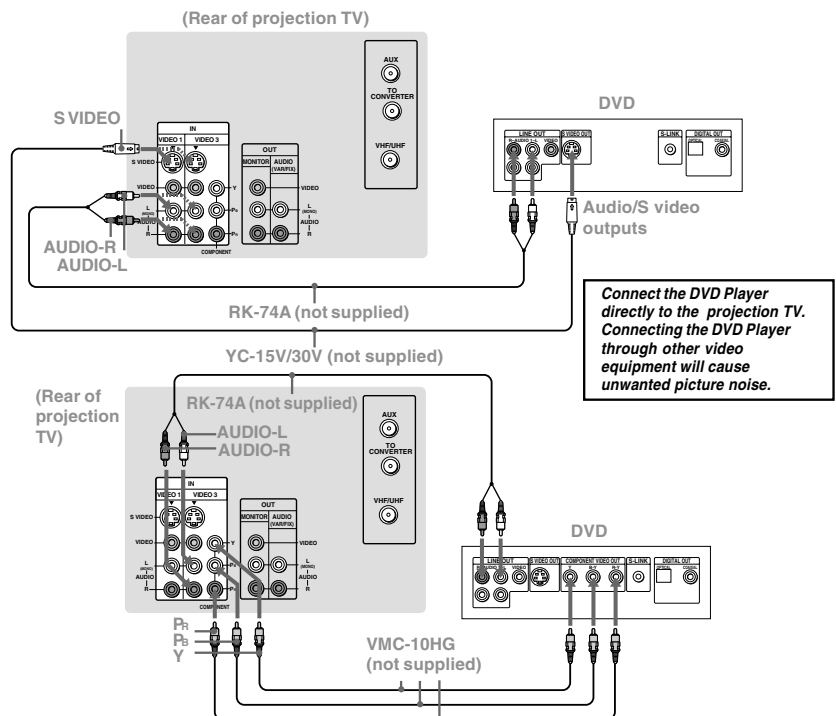

9

Installing and Connecting the Projection TV (continued)

Disconnect all power sources before making any connections.

Connecting an audio system (Upper illustration)

For more dynamic sound, connect an audio system to the projection TV.

- 1 Using an AUDIO cable, connect AUDIO (VAR/FIX) OUT on the projection TV to one of the unused Line inputs (e.g. Tape-2, AUX1, etc.) on the stereo.
- 2 Set the stereo to the chosen Line input and use the Audio menu to set the audio output and switch the TV's speakers off. (see "Salida de audio" and "Parlantes" on page 22)

Note:

- You can adjust VOLUME, "Graves," "Agudos," "Balance," "MTS/SAP" and "Efecto" with the supplied remote control. The control items except VOLUME can be adjusted only when "Salida de audio" is set to "Variable" in the Audio menu. (see "Salida de audio" on page 22)

Connecting a Sony SAVA series speaker system (Lower illustration)

Use this connection to control the speaker's Dolby Pro Logic surround system and super woofer mode with the remote control. (see "Control SAVA SP" on page 22)

- 1 Using the AUDIO cable supplied with the speaker to AUDIO (VAR/FIX) OUT on the projection TV.
- 2 Using the CONTROL S cable, connect CONTROL S IN on the speaker to CONTROL S OUT on the projection TV.

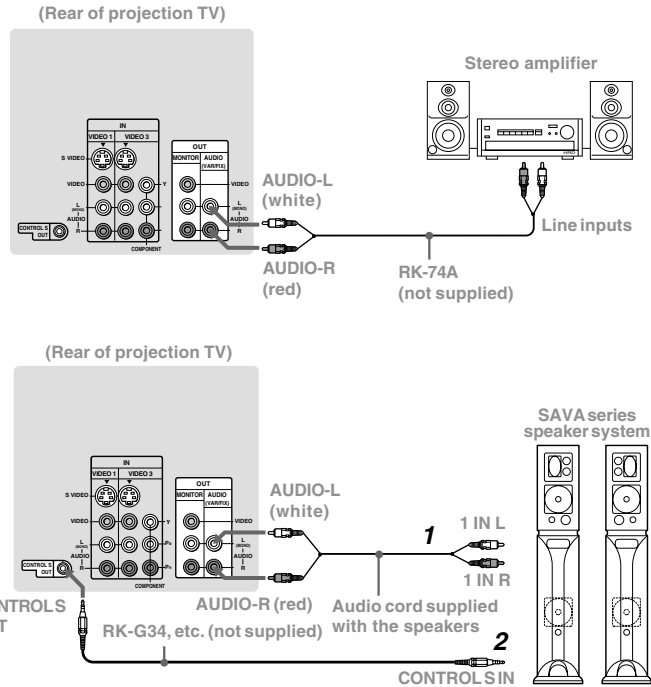

10

Basic Set Up

Using the Remote Control

Inserting the batteries

Insert two size AA (R6) batteries (supplied) by matching the + and - on the batteries to the diagram inside the remote control's battery compartment.

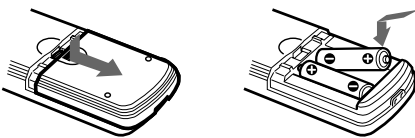

Notes:

- Remove the batteries to avoid damage from possible battery leakage whenever you anticipate that the remote control will not be used for an extended period.
- Handle the remote control with care. Avoid dropping it, getting it wet, or placing it in direct sunlight, near a heater or where the humidity is high.
- Your remote control can be programmed to operate most video equipment. (see "Operating Video Equipment" on page 30)

Setting Up the Projection TV Automatically

The AUTO SET UP feature will allow you to set the on-screen language and set all receivable channels.

The AUTO SET UP feature does not apply for installations that use a cable box for all channel selection.

You can also set up the projection TV manually. (see "Using the Ajuste de canal Menu" on pages 24 and 25)

Notes:

- Before you perform AUTO SET UP again, make sure that the input from ANT (not AUX) is selected by pressing ANT until "AUX" does not appear next to the channel number.
- Perform this function during the day, with the antenna and/or cable properly connected, to ensure that all available channels will be broadcasting and receivable.
- When you perform AUTO SET UP, all the settings in the Video, and Audio menus are reset to the factory settings.

(continued)

11

Basic Set Up (continued)

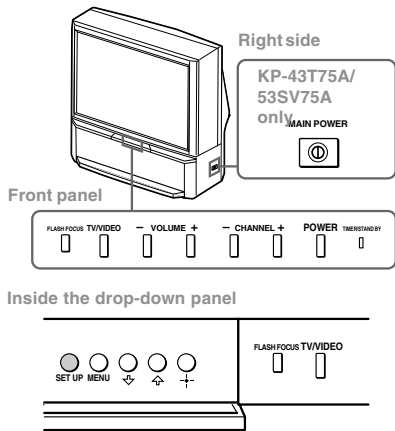

1 Turn on the projector TV.

For KP-43T75A/53SV75A only

- ① Depress MAIN POWER on the right side of the projection TV. The projection TV enters standby mode and the TIMER/STANDBY indicator lights in red.

- ② Press POWER on the projection TV. The TIMER/STANDBY indicator lights in green.

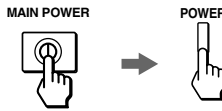

For KP-43T75C/53SV75C/61SV75C only

Press POWER on the projector TV.



- 2 Press SET UP inside the drop-down panel. The AUTO SET UP screen appears.

The AUTO SET UP screen appears.



KP-43T75A/53SV75A only

English : [CH+]
Español : [CH-]
Portugués : [VOL+]
Auto Set Up : [VOL-]
Primero conecte el cable antena.
Oprima [SET UP] para salir.

KP-43T75C/53SV75C/61SV75C only

English : [CH+]
Español : [CH-]
Français : [VOL+]
Auto Set Up : [VOL-]
Primero conecte el cable antena.
Oprima [SET UP] para salir.

- 3 Press CHANNEL +, CHANNEL - or VOLUME + to select the desired on-screen language: English, Español or Português (KP-43T75A/53SV75A), or English, Español or Français (KP-43T75C/53SV75C/61SV75C).

The screen will change to reflect your choice.

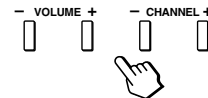

- 4 Press VOLUME - to continue.

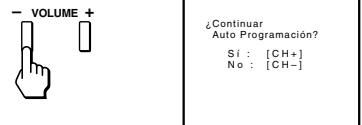

12

- 5 Press CHANNEL + to preset channels automatically.

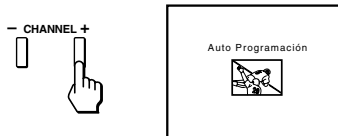

“Auto Programación” appears and the projection TV starts scanning and presetting channels automatically. While scanning, the received channel will be displayed on the sub screen. When all the receivable channels are stored, the lowest numbered channel is displayed.

To perform AUTO SET UP again

Press SET UP inside the drop-down panel on the projection TV and perform steps 3-5 on pages 12 and 13.

Press SET UP again to exit.

Adjusting the Convergence Automatically (FLASH FOCUS)

The projection tube image appears on the screen in three layers (red, green and blue). If they do not converge, the color is poor and the picture blurs.

Before you use your projection TV, be sure to adjust the convergence.

The FLASH FOCUS feature allows you to adjust the convergence automatically.

Tips

- It is recommended to perform FLASH FOCUS about 30 minutes after the projection TV is first turned on.
- You can also perform FLASH FOCUS using the Ajustes menu on page 29.

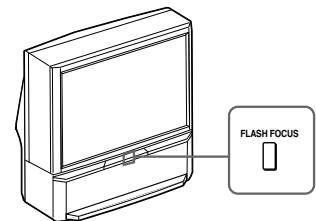

Press FLASH FOCUS.

The cross pattern appears and FLASH FOCUS begins to work. The adjustment is completed when the cross pattern becomes white.

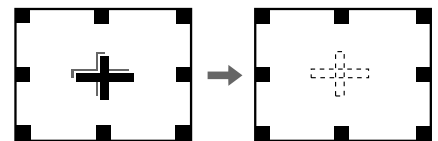

Note:

- FLASH FOCUS is canceled if you perform any other function while FLASH FOCUS is working.

13

Using Your New Projection TV

Watching the TV

Many TV features can be accessed directly through the remote control. The following chart will explain the function of some buttons found on your remote control.

Using the White Labeled Buttons for Projection TV Operations	
MAIN POWER <i>(on the right side of the projection TV)</i>	Switches the projection TV on and off.
TV (FUNCTION)	Activates the remote control for use with the projection TV.
TV POWER	Turns the projection TV on and off. If a video input indication (e.g., VIDEO 1, VIDEO 2) appears on the screen, press TV/VIDEO until a channel number appears.
0-9 and ENTER	Use for direct channel selection. Press 0-9 to select a channel (for example, to select channel 10, press 1 and 0). The channel will change after 2 seconds, or you can press ENTER for immediate selection.
CH +/-	Press to scan through the channels (+ up or - down). Speed Surf 1 Press and hold CH + or - to change the channel number rapidly. 2 Release to display the desired channel.
VOL +/-	Press to adjust the volume (+ up or - down).
MUTING	Press to mute the sound. "Suprimir el sonido" will appear on the screen and will dim three seconds later. To restore sound, press again or press VOL +.

14

PICTURE MODE

Press PICTURE MODE repeatedly to directly choose one of five different video modes that best suits the program you are watching.

Vivido: Select for enhanced picture contrast and sharpness.

Estándar: Select to display a standard picture for normal viewing environments.

Películas: Select to display a finely detailed picture for low light environments.

Personal 1, Personal 2: Select to customize the "Ajuste de imagen" of the Video menu according to your personal preference.

When you select "Películas," "Personal 1" or "Personal 2," you can also perform the "Ajuste de imagen" (such as "Brillo," "Color," etc.) to suit your taste. For details, see "Modo" on page 20.

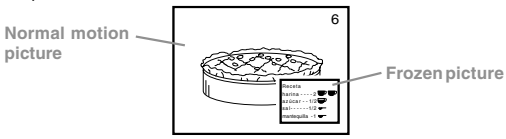
Using the White Labeled Buttons for Projection TV Operations	
TV/VIDEO	Press repeatedly to scroll through available video inputs: TV, VIDEO 1, VIDEO 2 and VIDEO 3 . If you select "Omitir" as a "Etiqueta de video" in the Ajustes menu, your projection TV will skip the video input you selected. (see "Etiqueta de video" on page 29)
JUMP	Press to alternate or <i>jump</i> back and forth between two channels. The projection TV will jump between the current channel and the last channel selected using the 0-9 buttons.
FREEZE <i>(yellow labeled button)</i>	This is useful when you need to copy down information that appears on the TV's screen. Press to <i>freeze</i> the desired picture. The frozen picture is displayed in the window picture while viewing the normal picture of the current channel in the main picture.  To change the location of the window picture, press \uparrow , \downarrow , \leftarrow or \rightarrow . Press FREEZE again to display the normal picture.
DISPLAY	Press to display the channel number, current time, channel caption (if set), and MTS/SAP mode (if SAP is selected). The SAP indication disappears and the other indications dim three seconds later. To turn the display off, press DISPLAY again.





REFER TO THE ILLUSTRATION OF THE REMOTE CONTROL ON THE INSIDE FRONT COVER OF THIS MANUAL AS YOU REVIEW THIS CHART

(continued)

15

Using Your New Projection TV (continued)

Using the White Labeled Buttons for Projection TV Operations	
	Press repeatedly to scroll through available displays: XDS (Extended Data Service) Displays a network name, program name, program type, program length, program description, call letters and time of the show if the broadcaster offers this service. Caption Vision Displayed on the screen if the broadcaster offers this service. (see "Caption Vision" on page 28) No display "Off" appears and the display is canceled.
SLEEP	Press repeatedly until the projection TV displays the approximate time in minutes (30, 60, or 90) that you want the projection TV to remain on before shutting off automatically. Cancel by pressing until "Sleep Off" appears.
ANT (AUX input)	Press to change between the VHF/UHF input and the AUX input. (for detailed connection information, see "Cable and antenna" or "Cable box and cable" on page 5)
MTS/SAP	Press to scroll through the Multi-channel TV Sound (MTS) options: Estéreo, SAP and Mono (KP-43T75A/53SV75A) ; Estéreo, SAP, Mono and SAP auto (KP-43T75C/53SV75C/61SV75C). (see "MTS/SAP" on page 21)
	Press to select an audio option: Simulado, No, BBE and Surround. (see "Efecto" on page 21)
TV/VTR	Press when you are finished using a VCR and you want to switch to the TV input. The VCR power will remain on.
SYSTEM OFF	Press to turn off the projection TV and all other Sony equipment.



REFER TO THE ILLUSTRATION OF THE REMOTE CONTROL ON THE INSIDE FRONT COVER OF THIS MANUAL AS YOU REVIEW THIS CHART

16

Watching Two Programs at One Time — PIP

The Picture-in-Picture (PIP) feature allows you to view two channels simultaneously, one in the full size "main" picture and one in a smaller "window" picture.



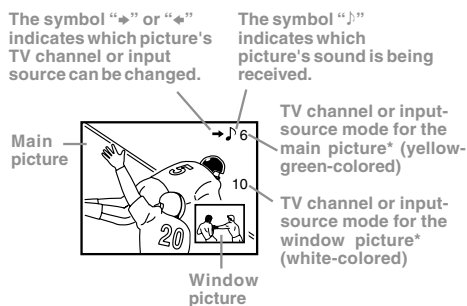





You can move the window picture to any location on the screen.



* It will dim in about 3 seconds.







Tip 

If you press RESET in PIP mode, the window picture will move to the bottom right (factory-preset location).

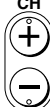
Using the Yellow Labeled Buttons for PIP Operations	
	Press to display a window picture. Each time you press this button, the picture size will change (1/9 → 1/16 → no display). ↑ ↓ To close the window picture, press PIP repeatedly until it disappears.
POSITION  or 	Press POSITION repeatedly to change the location of the window picture (counterclockwise) around the main picture. You can also change the location by pressing the  ,  ,  , or  button. The window picture moves in the direction of the arrow indicated on the pressed button.
ACTIVE 	Press to select either the main or window picture in order to change the TV channel or video source using the white labeled buttons below. The symbol "♦" (or "◆") will appear to indicate which picture's channel or input mode can be changed.
TV/VIDEO  (white labeled button)	Press repeatedly to scroll through the available video inputs for the picture on which the symbol "♦" (or "◆") is displayed. (see "TV/VIDEO" on page 15)

17

Using Your New Projection TV (continued)

Using the Yellow Labeled Buttons for PIP Operations	
 or  or  and ENTER (white labeled button)	Press to select the TV channel on which the symbol "➔" is displayed. (for details, see "Watching the TV" on page 14) Speed Surf 1 Press and hold CH + or – to change the channel number rapidly. 2 Release to display the desired channel.
 (white labeled button)	Press to change between the VHF/UHF input and the AUX input for the picture on which the symbol "➔" (or "➔") is displayed.
	Press to alternate sound between the main picture and the window picture. The symbol "♪" will appear for a few seconds to indicate which picture's sound is being received.
	This is useful when you need to copy down information of the main picture. Press to freeze the desired scene in the main picture. The frozen picture is displayed in the window picture while viewing the normal picture in the main picture. The window picture size is automatically changed to 1/9 if it was 1/16. Press again to resume normal PIP viewing.
	Press to switch the audio and video of the main picture and the window picture. Each time you press SWAP, the picture and sound of the two will be exchanged.



REFER TO THE ILLUSTRATION OF THE REMOTE CONTROL ON THE INSIDE FRONT COVER OF THIS MANUAL AS YOU REVIEW THIS CHART





Note:

- If one of the pictures received through PIP is snowy, the entire screen may become unstable. In this case, erase the snowy channel. (see "Canal omitir/agregar" on page 25)

18

Adjusting Your SET UP (menus)



Learning Menu Selection

Use the MENU button to access a menu and use the , , ,  and  buttons to alter the settings. Use the following example to learn how to modify settings.

- Press the MENU button.



The main menu appears.



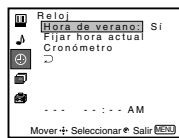
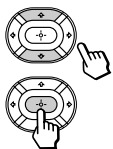

- Press  or  to highlight the desired menu and press  to activate it.

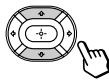

You may also press  to activate your selection.

- Press  or  to highlight the desired option.



- Press .

Options for your selection (Pop-up menu or Adjusting menu) will be displayed.





Pop-up menu



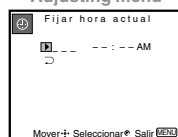

Adjusting menu

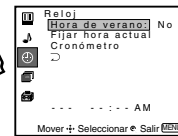
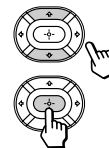

- Press  or  to make your selection and press  to activate it. The previous screen will reappear.



Some adjustment menus may require further operations. For details, see each menu option.

To return to the previous screen (except for the slider adjustment menus), choose "" at the bottom of the menu and press  or .



- Once you have completed all menu corrections, press MENU to exit the menu screens.



To exit from the menus at any time

Press MENU.

Tip 

You can also use the MENU, ,  and  buttons inside the front drop-down panel of the projection TV for the menu selection.

19

Adjusting Your SET UP (menus) (continued)

Using the Video Menu



For detailed information on using the remote control to modify menu settings, refer to “Learning Menu Selection” on page 19.

To select the Video menu:

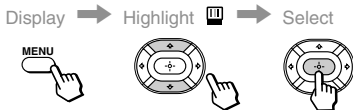

To restore the factory settings

Press RESET on the remote control while the Video menu is selected. To restore each “Modo” to the factory setting, press RESET after selecting the mode to be reset.

Modo <i>Customized picture viewing</i>	<p>You can choose one of five different video modes that best suits the program you are watching. You can also perform the “Ajuste de imagen” (such as “Brillo,” “Color,” etc.) for “Películas,” “Personal 1” or “Personal 2” to suit your taste.</p> <p>Vívido: Select for enhanced picture contrast and sharpness.</p> <p>Estándar: Select to display a standard picture for normal viewing environments.</p> <p>Películas: Select to display a finely detailed picture for low light environments.</p> <p>Personal 1, Personal 2: Select to customize the “Ajuste de imagen” of the Video menu according to your personal preference.</p> <p>Press PICTURE MODE on the remote control for direct selection of a “Modo” setting.</p>
Ajuste de imagen <i>Picture adjustment</i>	<p>First select “Películas,” “Personal 1” or “Personal 2” from “Modo,” then highlight the desired option using the ▲ or ▼ button and press + to display the adjusting slider of the selected option.</p> <p>Contraste: Adjust slider right (up) to increase picture contrast; left (down) to decrease it.</p> <p>Brillo: Adjust slider right (up) to brighten the picture; left (down) to darken it.</p> <p>Color: Adjust slider right (up) to increase color intensity; left (down) to decrease it.</p> <p>Tinte: Adjust slider right (up) to increase the green tones; left (down) to increase the red tones.</p> <p>Nitidez: Adjust slider right (up) to sharpen the picture; left (down) to soften it.</p>
Trinitone <i>White intensity adjustment</i>	<p>Alto: Select to give the white colors a blueish tint.</p> <p>Medio: Select to give the white colors a neutral tint.</p> <p>Normal: Select to give the white colors a reddish tint.</p>
Reduccion de ruido <i>Nose reduction</i>	<p>“Reduccion de ruido” can only be set when the TV input is selected and “Modo” of the Video menu is set to “Películas,” “Personal 1” or “Personal 2”.</p> <p>Select Si to reduce picture noise.</p> <p>Select No to cancel the feature.</p>

20

Using the Audio Menu



For detailed information on using the remote control to modify menu settings, refer to “Learning Menu Selection” on page 19.

To select the Audio menu:



To restore the factory settings

Press RESET on the remote control while the Audio menu is selected.

* The BBE is manufactured by Sony Corporation under license from BBE Sound, Inc. It is covered by U.S. Patent No. 4,638,258 and No. 4,482,866. The word “BBE” and the BBE symbol are the trademarks of BBE Sound, Inc.

Agudos <i>Sound adjustment</i>	<p>Adjust slider right (up) to increase high pitched sounds.</p> <p>Adjust slider left (down) to decrease high pitched sounds.</p>
Graves <i>Sound adjustment</i>	<p>Adjust slider right (up) to increase low pitched sounds.</p> <p>Adjust slider left (down) to decrease low pitched sounds.</p>
Balance <i>Sound adjustment</i>	<p>Adjust slider right (up) to emphasize right speaker volume.</p> <p>Adjust slider left (down) to emphasize left speaker volume.</p>
MTS/SAP <i>Enjoy stereo, bilingual and mono programs.</i>	<p>When the sound is intermittent due to poor reception conditions, select “Estéreo” or “SAP.”</p> <p>Estéreo: Select for stereo reception when viewing a program broadcast in stereo.</p> <p>SAP: Select to listen to a bilingual broadcast. (non-SAP programs will be muted when this feature is selected)</p> <p>Mono: Select for mono reception. (use to reduce noise during stereo broadcasts)</p> <p>SAP auto: Select to listen to SAP when a SAP program is broadcast and return to stereo reception automatically for non-SAP programs. (KP-43T75C/53V75C/61SV75C ONLY)</p> <p>Quick MTS access: Press MTS/SAP on the remote control to cycle through the “MTS/SAP” options as follows:</p> <p>Estéreo → SAP → Mono (KP-43T75A/53V75A)</p> <p>Estéreo → SAP → Mono → SAP auto (KP-43T75C/53SV75C/61SV75C)</p>
Auto Volumen <i>Adjust the sound level.</i>	<p>Sí: Sound output coming from TV speakers have the volume level equalized for all channel audio inputs when broadcasts have different sound transmission levels.</p> <p>No: Sound output coming from the TV speakers varies according to the received channel.</p>
Efecto <i>Customizes surround sound effects based on the program's audio type.</i>	<p>“Efecto” can only be set when “Parlantes” is set to “Si” or “No.”</p> <p>Simulado: Adds a surround-like effect to mono programs.</p> <p>Surround: Simulates sound with the atmosphere of a movie theater or a concert hall for stereo programs.</p> <p>BBE*: Centers the sound intensity to the front, creating an effect as if you were seated in front of an orchestra.</p> <p>No: Normal stereo or mono reception.</p> <p>Quick Effect access: Press Efecto on the remote control to cycle through the “Efecto” options as follows: Simulado → Surround → BBE → No.</p>

(continued) 21

Adjusting Your SET UP (menus) (continued)

Parlantes <i>Custom selection of audio output source</i>	<p>Sí: Select to listen to the sound from the projection TV speakers alone.</p> <p>No: Select to turn off the projection TV speakers and listen to the projection TV's sound only through an external audio system's speakers.</p> <p>SAVA SP: Select to turn off the projection TV speakers and listen to the projection TV's sound only through the Sony SAVA series speaker system. You can adjust volume, muting, "Modo surround," and "Modo superwoofer" with the projection TV's remote control. (see "Control SAVA SP" below)</p>
Salida de audio <i>Easy control of volume adjustment</i>	<p>"Salida de audio" can only be set when "Parlantes" is set to "No."</p> <p>Fijo: Sound output is held at a fixed level through the audio system. Use the AV receiver's remote control to adjust the volume.</p> <p>Variable: Sound output varies according to the TV settings. Useful when you want to use your remote control to control the output of a separate audio system.</p>
Control SAVA SP <i>Controls Sony SAVA speaker's mode.</i>	<p>"Control SAVA SP" can only be set when Sony SAVA speaker system is connected to the AUDIO (VAR/FIX) OUT connectors and "Parlantes" is set to "SAVA SP." (see "Parlantes" above)</p> <p>You can also adjust the SAVA speaker's volume using VOL +/- of the projection TV's remote control.</p> <p>Modo surround: Select to activate the SAVA Speaker's surround mode.</p> <p>Modo superwoofer: Select to activate the SAVA Speaker's super woofer mode.</p>

22

Using the Reloj Menu

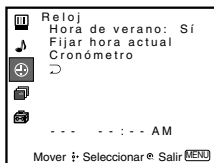

After setting the clock you can use the timer to turn the projection TV on and off.

For detailed information on using the remote control to modify menu settings, refer to "Learning Menu Selection" on page 19.

To select the Reloj menu:

Display → Highlight → Select

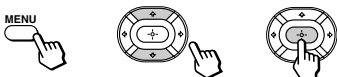

Tip

- Set daylight saving time before setting the clock. Any loss of power will cause these settings to be erased.
- To maintain clock and timer settings, MAIN POWER must be left in ON position. (KP-43T75A/53SV75A only)

Hora de verano <i>Automatically adjusts the time.</i>	<p>Spring: Select Sí to compensate for Daylight Saving Time. The current time automatically moves ahead one hour.</p> <p>Fall: Select No at the end of Daylight Saving Time. The current time moves back one hour.</p>
Fijar hora actual <i>Necessary for the Timer.</i>	<ol style="list-style-type: none"> 1 Press \oplus, then press \uparrow or \downarrow until the current day (Sun-Sat) is displayed, and press \oplus. 2 Press \uparrow or \downarrow until the current hour (1-12) and AM/PM is displayed, and press \oplus. 3 Press \uparrow or \downarrow until the current minute (00-59) is displayed, and press \oplus. <p>The clock has now started. Press MENU to exit.</p>
Cronómetro <i>Wake up or scheduled viewing.</i>	<ol style="list-style-type: none"> 1 Press \uparrow or \downarrow until the desired day or range of days (Every Sun-Sat, Every Mon-Fri, Sunday, Monday, ... Saturday, Every Sunday, ... Every Saturday) is displayed, and press \oplus. 2 Press \uparrow or \downarrow until the time (hours and minutes) that you want the projection TV to remain on is displayed, and then press \oplus. 3 Press \uparrow or \downarrow to set the time duration (maximum of 6 hours) and press \oplus. 4 Press \uparrow or \downarrow to select the desired channel and press \oplus. <p>The timer is now set. The TIMER/STAND BY indicator on your projection TV will be lit (For KP-43T75A/53SV75A, the indicator will be orange). Press MENU to exit. To cancel your timer setting, press RESET while in the Cronómetro window. Performing Auto programación will erase all "Reloj" settings.</p>

23

Adjusting Your SET UP (menus) (continued)

Using the Ajustes de canal Menu

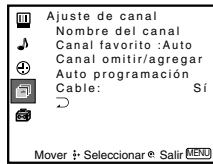

For detailed information on using the remote control to modify menu settings, refer to "Learning Menu Selection" on page 19.

To select the Ajustes de canal menu:

Display → Highlight → Select

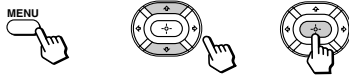

Nombre del canal

Easy recognition of the channel you are watching

You can add a caption for up to 32 channels of VHF/UHF input.

With the "Nombre del canal" window open:

1 Press (+) and then press ▲ or ▼ to select the desired channel. You can view the channel that is selected with the Nombre del canal menu in the sub screen.

2 Press (+).

3 Press ▲ or ▼ to display the first letter or number of the caption and press (+) to select it. Repeat until up to five digits are selected.

4 Press (+).

To erase a caption, press RESET.

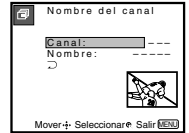

Canal favorito

User's favorite channels

The Canal favorito feature enables easy access to the eight channels that you preset (or the last channel that you were watching).

(for details on how to set up this feature, see "Setting and Selecting Canal favorito" on page 26)

24

<p>Canal omitir/agregar <i>Skips unnecessary channels.</i></p>	<p>After AUTO SET UP, you can erase unnecessary channels from the channel preset memory. With the "Canal omitir/agregar" window open:</p> <ol style="list-style-type: none"> Press ▲ or ▼ to select the desired channel. You can view the channel that is selected with the Canal omitir/agregar menu in the sub screen. You can also use CH +/- or 0-9 and ENTER buttons. Press (+). Press ▲ or ▼ to select omitir, and press (+). The selected channel will be erased. If you want to re-enter the skipped channel, follow the steps above and select agregar. 	
<p>Auto programación <i>Automatic channel presetting</i></p>	<p>Select Sí to signal the projection TV to automatically program all receivable channels. When all the receivable channels are stored, the lowest numbered channel is displayed. Select No to cancel Auto programación.</p>	
<p>Cable <i>Cable system setting</i></p>	<p>Select Sí if your projection TV is connected to a cable system. Select No if your projection TV is connected to an antenna.</p>	

Adjusting Your SET UP (menus) (continued)

Setting and Selecting Canal favorito

The Canal favorito feature of your projection TV enables easy access to the eight channels that you preset (or the last channel that you were watching).

Your Canal favorito options can be set automatically or manually.

The factory setting for "Canal favorito" is "Auto."

When "Canal favorito" is set to "Auto," the last eight channels selected with the 0-9 buttons will be set as Canal favorito options. If you want to input your own selections as Canal favorito settings, set to "Manual."

Setting Canal favorito manually

- 1 Select "Canal favorito" from the Ajuste de canal menu. (see page 24)

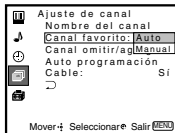

- 2 Press \uparrow or \downarrow to select "Manual" and press \oplus .

The Canal favorito menu will appear. If you set Nombre del canal names, they will also be displayed. (see "Nombre del canal" on page 24)

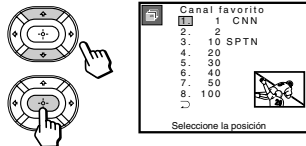

- 3 Press \uparrow or \downarrow to select a position (1-8), and press \oplus .

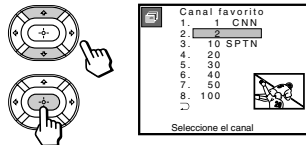

- 4 Press \uparrow or \downarrow to select a channel and press \oplus .

You have now selected a favorite channel.

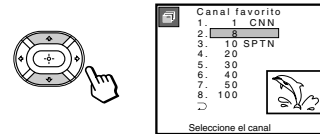

- 5 Use \uparrow and \downarrow to program other favorite channels. (Follow steps 3 and 4.)

- 6 Press MENU when you have finished.

Your favorite channels are now ready for use.

26

Changing Canal favorito choices

You have the option of returning to the Canal favorito screen to adjust any of your favorite channel choices.

Simply proceed as described in "Setting Canal favorito manually" (skip step 2 if "Manual" is already selected).

When you reach step 3, select the position you want to change and press \oplus . Press \uparrow or \downarrow to select a new channel.

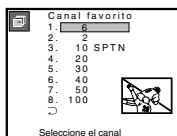

Press MENU when you are done.

Using Canal favorito

You can use the Canal favorito feature to directly select the channel you want to watch.

- 1 Press \oplus once.

The favorite channel menu and a window picture will be superimposed over the current channel. The window picture displays the channel selected from the menu.

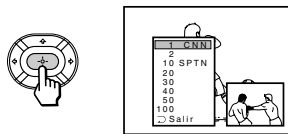

- 2 Press \uparrow or \downarrow to select the channel that you wish to view from the menu.

The picture of the selected channel will be displayed in the window picture.

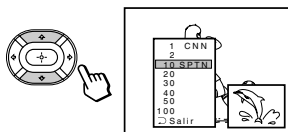

- 3 Press \oplus to select the channel.

The selected channel will be displayed for normal viewing.

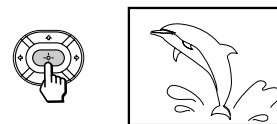

To cancel the favorite channel menu before selecting a channel, press \uparrow or \downarrow to select "Salir" at the bottom of the menu and press \oplus .

27

Adjusting Your SET UP (menus) (continued)

Using the Ajustes Menu



For detailed information on using the remote control to modify menu settings, refer to “Learning Menu Selection” on page 19.

To select the Ajustes menu:

Display → Highlight → Select

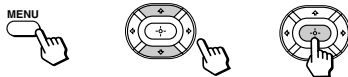

Caption Vision

Television closed
caption display

Some programs are broadcast with Caption Vision. To display “Caption Vision,” select **CC**1, **CC**2, **CC**3, **CC**4, TEXT1, TEXT2, TEXT3 or TEXT4 from the menu. Then press the **CC** button until “Caption Vision” is displayed.

CC1, **CC**2, **CC**3 or **CC**4 displays a printed version of the dialogue or sound effects of a program. (The mode should be set to **CC**1 for most programs.) TEXT1, TEXT2, TEXT3, or TEXT4 displays network/station information presented using either half or the whole screen.

Notes:

- Poor reception of TV programs can cause errors in Caption Vision and XDS. Captions may appear with a white box or other errors instead of the intended text.
- XDS, Caption Vision, and the status display cannot be used at the same time.

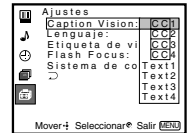

Lenguaje

Preferred language

Select from available languages to display all menus in your language of choice: **English, Español** and **Português** for the KP-43T75A/53SV75A **English, Español** and **Français** for the KP-43T75C/53SV75C/61SV75C

28

<p>Etiqueta de video Easy recognition of connected equipment (e.g. DVD, VHS, etc.)</p>	<p>This feature allows you to label each input mode so that you can easily identify the connected equipment (e.g. you can label VIDEO 1 IN as VHS).</p> <p>With the “Etiqueta de video” window open:</p> <ol style="list-style-type: none"> Press ▲ or ▼ to select the input mode you want to label and press (+). Press ▲ or ▼ to select the label and press (+). <p>Etiqueta de video Options: VIDEO 1: VIDEO 1, VHS, 8mm, Beta, LD, DVD, AV RECEIVER, Omitir VIDEO 2/3: VIDEO 2/VIDEO 3, VHS, 8mm, Beta, LD, DVD, Omitir <i>If you select “Omitir,” your projection TV will skip this connection when you scan through video sources using the TV/VIDEO button.</i></p>
<p>Flash Focus Automatic convergence adjustment</p>	<p>Select Sí and press (+) to start Flash Focus adjustment. When the adjustment is completed, the cross pattern on the screen becomes white. (for details, see page 13) Select No to cancel Flash Focus.</p>
<p>Sistema de color Select the TV color system. (KP-43T75A/53SV75A only)</p>	<p>This feature allows you to set the TV color system for each input mode. Normally set it to “Auto.” If the picture does not appear clearly, set the color system to “PAL-N” manually.</p> <p>With the “Sistema de color” window open:</p> <ol style="list-style-type: none"> Press ▲ or ▼ to select the input mode and press (+). Press ▲ or ▼ to select the TV color system (Auto → PAL-M → PAL-N → NTSC) and press (+).

29

Operating Video Equipment

Setting the Manufacturer's Code

You can use the supplied remote control to operate Sony or non-Sony video equipment that has an infrared sensor.

Press CODE SET, DVD/VTR (FUNCTION), and the 0-9 buttons to enter the manufacturer's code number (see the following chart), then press ENTER.

For example, to operate a Sony 8mm VCR:

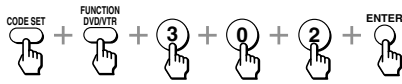

If the remote control doesn't work

- See the tips on page 32.

VCR manufacturer code numbers

Manufacturer	Code
Sony (VHS VCR)	301
Sony (8mm VCR)	302
Sony (Beta, ED Beta, VCRs)	303
Aiwa	338
Admiral (M. Ward)	327
Audio Dynamic	314, 337
Bell & Howell (M. Ward)	330
Broksonic	319, 317
Canon	309, 308
Citizen	332
Craig	302, 332
Curtis Mathis	304, 338, 309
Daewoo	341, 312, 309
DBX	314, 336, 337
Dimensia	304
Emerson	319, 320, 316, 317, 318, 341
Fisher	330, 335
Funai	338
General Electric	329, 304, 309
Go Video	340, 339, 322
Goldstar	332
Hitachi	306, 304, 305, 338
Instant Replay	309, 308
JC Penney	309, 305, 304, 330, 314, 336, 337
JVC	314, 336, 337
Kenwood	314, 336, 332, 337
LXI (Sears)	332, 305, 330, 335, 338
Magnavox	308, 309, 310
Marantz	314, 336, 337
Marta	332
Memorex	309, 335

Minolta	305, 304
Mitsubishi/MGA	323, 324, 325, 326
Multitech	325, 338, 321
NEC	314, 336, 337
Olympic	309, 308
Optimus	327
Panasonic	308, 309, 306, 307
Pentax	305, 304
Philco	308, 309
Philips	308, 309, 310
Pioneer	308
Quasar	308, 309, 306
RCA/PROSCAN	304, 305, 308, 309, 311, 329, 312, 313, 310
Realistic	309, 330, 328, 335, 324, 338
Sansui	314
Samsung	322, 313, 321
Sanyo	330, 335
Scott	312, 313, 321, 335, 323, 324, 325, 326
Sharp	327, 328
Signature 2000 (M. Ward)	338, 327
Sylvania	308, 309, 338, 310
Symphonic	338
SV2000	338
Tashiro	332
Tatung	314, 336, 337
Teac	314, 336, 338, 337
Technics	309, 308
Teknica	338
Toshiba	312, 311
Wards	327, 328, 335, 331, 332
Yamaha	330, 314, 336, 337
Zenith	331

30

MDP manufacturer code numbers

Manufacturer	Code
Sony	701
Panasonic	704, 710
Mistubishi	702

DVD Player manufacturer code numbers

Manufacturer	Code
Sony	751
Panasonic	753
Pioneer	752
RCA	755
Toshiba	754

Tips

- In some rare cases, you may not be able to operate your non-Sony video equipment with the supplied remote control. In this case, please use the equipment's own remote control.
- When you remove the batteries, the code number may revert to the factory setting.

To operate video equipment

- 1 Press DVD/VTR (FUNCTION).
- 2 Use the VCR/DVD/MDP operation buttons indicated in the following tables.

Operating a VCR using the remote control

To turn On/Off	Press DVD/VTR (POWER). [Green Button]
To select a channel	Press the 0 – 9 buttons.
To change channels	Press CH +/-.
To record	Press ▶ while pressing ● .
To play	Press ▶ .
To stop	Press ■ .
To fast forward	Press ▶▶ .
To rewind the tape	Press ◀◀ .
To pause	Press . Press again to resume normal playback.
To search the picture forward or backward	Press ▶▶ or ◀◀ during playback. Release to resume normal playback.
To change input mode	Press TV/VTR.

Operating an MDP using the remote control

To turn On/Off	Press DVD/VTR (POWER). [Green Button]
To play	Press ▶ .
To stop	Press ■ .
To pause	Press . Press again to resume normal playback.

To search the picture forward or backward Press **▶▶** or **◀◀** during playback. Release to resume normal playback.

To search a chapter forward or backward Press CH +/-.

Operating a DVD Player using the remote control

To turn On/Off	Press DVD/VTR (POWER). [Green Button]
To play	Press ▶ .
To stop	Press ■ .
To pause	Press . Press again to resume normal playback.
To step through different tracks of an audio disc	Press ▶▶ to step forward or ◀◀ to step backward.
To step through different chapters of a video disc	Press CH + to step forward or CH – to step backward.
To select tracks directly	Press 0-9 buttons.
To display the menu (Set up)	Press MENU.

31

Operating a Cable Box

Setting the Manufacturer's Code

You can program the supplied remote control to operate a cable box.

Press CODE SET, SAT/CABLE (FUNCTION)*, and the 0-9 buttons to enter the manufacturer's code number (see the following chart), then press ENTER.

For example, to operate a Pioneer cable box:



Manufacturer code numbers (cable box)

Manufacturer	Code
Hamlin/Regal	222, 223, 224, 225, 226
Jerrold/G.I.	201, 202, 203, 204, 205, 222, 206, 207, 208, 218
Oak	227, 228, 229
Panasonic	219, 220, 221
Pioneer	214, 215
Scientific Atlanta	209, 210, 211
Tocom	216, 217
Zenith	212, 213

To operate the cable box

- 1 Press SAT/CABLE (POWER)* [Green Button] to turn on/off the cable box.
- 2 Press SAT/CABLE (FUNCTION)*.
- 3 For other operations, refer to the operating instructions that come with the equipment.

* The SAT/CABLE (POWER) and SAT/CABLE (FUNCTION) buttons cannot operate a satellite receiver (SAT) in Argentine and Chile even if it is connected to the projection TV.

If the remote control doesn't work

- Try repeating the set up procedures using the other codes listed for your equipment.

To operate the projection TV

Press TV (FUNCTION). Then use the projection TV control buttons to control the projection TV.

Tips

- If more than one code number is listed, try entering them one by one until you come to the correct code for your equipment.
- If you enter a new code number, the code number you previously entered at that setting is erased.
- In some rare cases, you may not be able to operate your equipment with the supplied remote control. In this case, use the equipment's own remote control unit.
- Whenever you remove the batteries — to replace them, for example — if too much time is taken, the code numbers may revert to the factory setting and must be reset.

32

Troubleshooting

If, after reading the following instructions, you have additional questions related to the use of your Sony projection TV, please contact your nearest Sony Authorized Service Center.

The picture turns off and the TIMER/STAND BY indicator on the front panel flashes (self-diagnosis function)	<ul style="list-style-type: none"> • The projection TV is equipped with a self-diagnosis function. If there is a problem with your projection TV, the TIMER/STAND BY indicator on the front panel will flash repeatedly. Counting the number of flashes helps you inform qualified Sony Authorized Service Center of the projection TV's condition. • Press POWER on the projection TV to turn it off, then inform qualified Sony Authorized Service Center of the number of flashes.
No picture (screen not lit), no sound	<ul style="list-style-type: none"> • Make sure the power cord is plugged in. • Operate with the buttons on both the projection TV and the remote control. • Check to see if the TV/VIDEO setting is correct: when watching TV, set to TV, and when watching video tapes, set to VIDEO 1, 2, or 3. • Try another channel. <i>It could be station trouble.</i> • Perform AUTO SET UP again using the SET UP button to return to the factory preset condition. (see "To perform AUTO SET UP again" on page 13)
Remote control does not operate	<ul style="list-style-type: none"> • Batteries could be weak. Replace the batteries. • Press TV (FUNCTION) when operating your projection TV. • Make sure the projection TV's power cord is connected securely to the wall outlet. • Locate the projection TV at least 3-4 feet away from fluorescent lights. • Check the polarity of the batteries.
Dark, poor or no picture (screen lit), good sound	<ul style="list-style-type: none"> • Adjust "Contraste" in the Video menu. (see "Ajuste de imagen" on page 20) • Adjust "Brillo" in the Video menu. (see "Ajuste de imagen" on page 20) • Check antenna/cable connections. • Perform AUTO SET UP again using the SET UP button to return to the factory preset condition. (see "To perform AUTO SET UP again" on page 13) • Adjust the convergence again using the FLASH FOCUS button. (see "Adjusting the Convergence Automatically (FLASH FOCUS)" on page 13)
Good picture, no sound	<ul style="list-style-type: none"> • Press MUTING so that "Suprimir el sonido" disappears from the screen. (see "MUTING" on page 14) • Check the MTS/SAP setting in the Audio menu. (see "MTS/SAP" on page 21) • Make sure "Parlantes" is set to "Si" in the Audio menu. (see "Parlantes" on page 22) • Perform AUTO SET UP again using the SET UP button to return to the factory preset condition. (see "To perform AUTO SET UP again" on page 13) • Set the appropriate TV color system in the Ajustes menu. (see "Sistema de color" on page 29)

(continued)

Troubleshooting (continued)

Cannot receive upper channels (UHF) when using an antenna	<ul style="list-style-type: none"> • Make sure "Cable" is "No" in the Ajuste de canal menu. (see "Cable" on page 25) • Use "Auto programación" to add receivable channels that are not presently in the TV's memory. (see "Auto programación" on page 25)
No color	<ul style="list-style-type: none"> • Adjust "Color" in the Video menu. (see "Ajuste de imagen" on page 20) • Black and white programs cannot be seen in color. • Perform AUTO SET UP again using the SET UP button to return to the factory preset condition. (see "To perform AUTO SET UP again" on page 13) • Set the appropriate TV color system in the Ajustes menu. (see "Sistema de color" on page 29)
Only snow and noise appear on the screen	<ul style="list-style-type: none"> • Check the "Cable" setting in the Ajuste de canal menu. (see "Cable" on page 25) • Check the antenna/cable connections. • Make sure the channel is broadcasting programs. • Press ANT to change the input mode. (see "ANT" on page 16) • Set the appropriate TV color system in the Ajustes menu. (see "Sistema de color" on page 29)
Dotted lines or stripes	<ul style="list-style-type: none"> • Adjust the antenna. • Keep the projection TV away from noise sources such as cars, neon signs or hair-dryers.
TV is fixed to one channel	<ul style="list-style-type: none"> • Use "Auto programación" to add receivable channels that are not presently in TV's memory. (see "Auto programación" on page 25)
Double images or ghosts	<ul style="list-style-type: none"> • Use a highly directional outdoor antenna or a cable (when the problem is caused by reflections from nearby mountains or tall buildings).
Cannot operate the menu	<ul style="list-style-type: none"> • If the item you want to choose appears in gray, you cannot select it. • Press the projection TV's power button off and on again.
Cannot receive any channels when using cable TV	<ul style="list-style-type: none"> • Make sure "Cable" is "SI" in the Ajuste de canal menu. (see "Cable" on page 25) • Use "Auto programación" to add receivable channels that are not presently in the TV's memory. (see "Auto programación" on page 25)
Cannot gain enough volume when using a cable box	<ul style="list-style-type: none"> • Increase the volume at the cable box. Then press TV (FUNCTION) and adjust the projection TV's volume.
Canal favorito does not display your choices	<ul style="list-style-type: none"> • Verify that "Canal favorito" is set to "Manual" in the Ajuste de canal menu. (see "Setting Canal favorito manually" on page 26)
Some video sources do not appear when you press TV/VIDEO	<ul style="list-style-type: none"> • Ensure that "Etiqueta de video" is not set to "Omitir." (see "Etiqueta de video" on page 29)
Recording through MONITOR OUT does not function properly when recording in PIP mode	<ul style="list-style-type: none"> • MONITOR OUT will not record both images in PIP. Only the main picture will be recorded. • If you are recording the main picture and you switch to the sound of the sub picture using the AUDIO button, the main picture will be recorded with sound from the other program.
Cannot play shooting games	<ul style="list-style-type: none"> • Some shooting games which involve pointing a light beam at the TV screen with an electronic gun or rifle cannot be used with this projection TV. For details, see the instruction manual supplied with the video game software.

SECTION 2 DISASSEMBLY

2-1. REAR BOARD REMOVAL

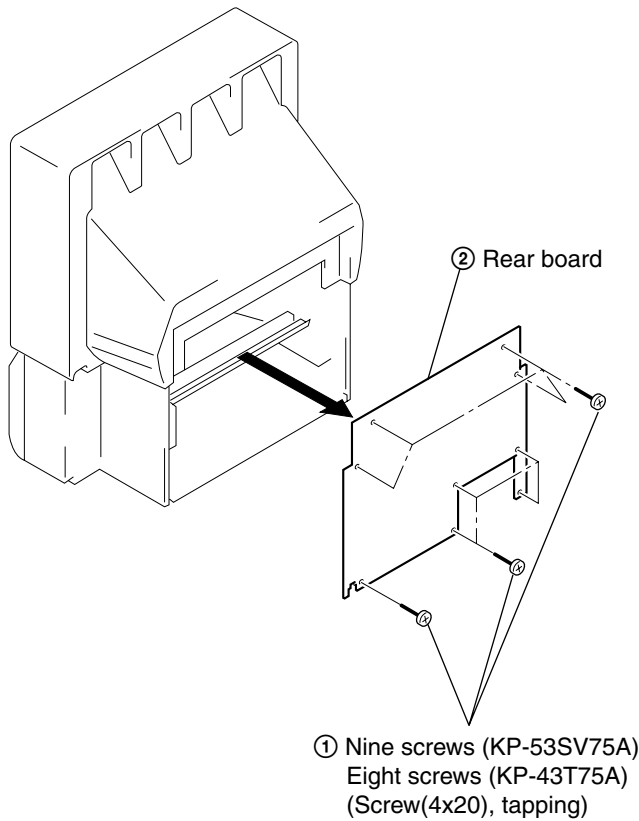

2-2. CHASSIS ASSY REMOVAL

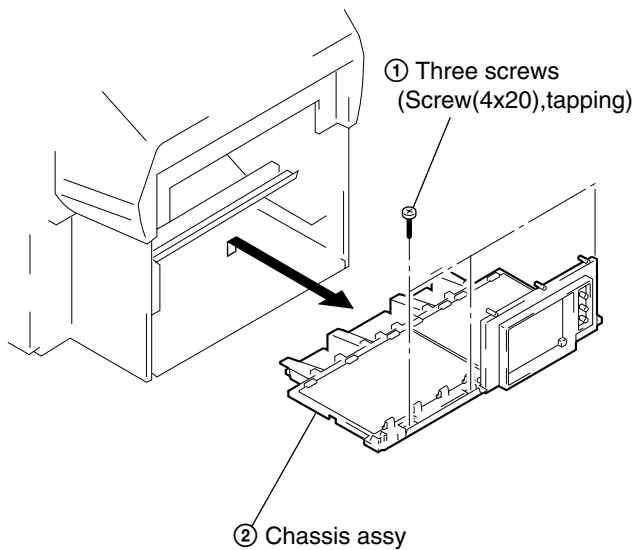

2-3. SERVICE POSITION

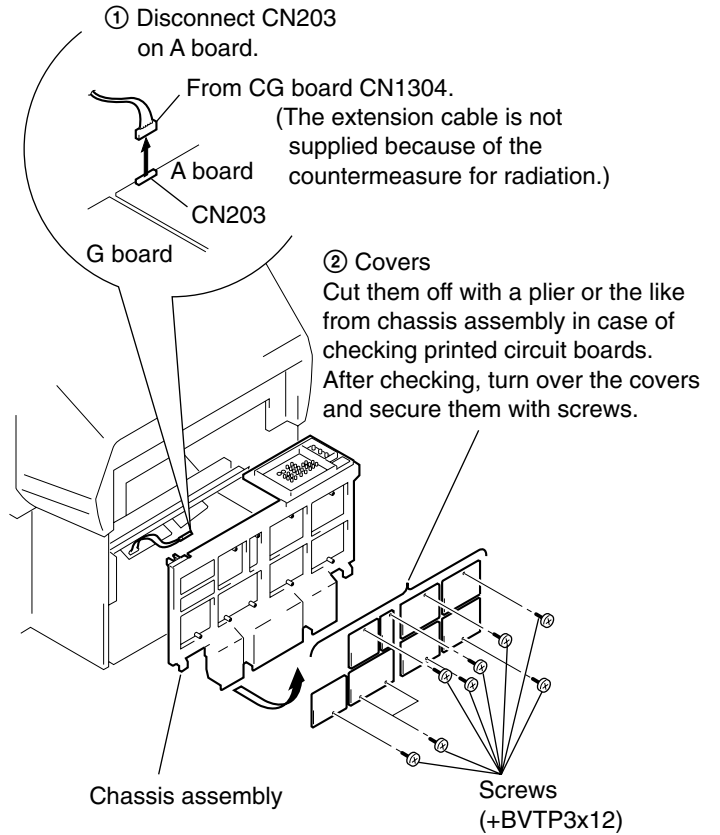

2-4. HA BOARD AND HB BOARD REMOVAL (KP-53SV75A)

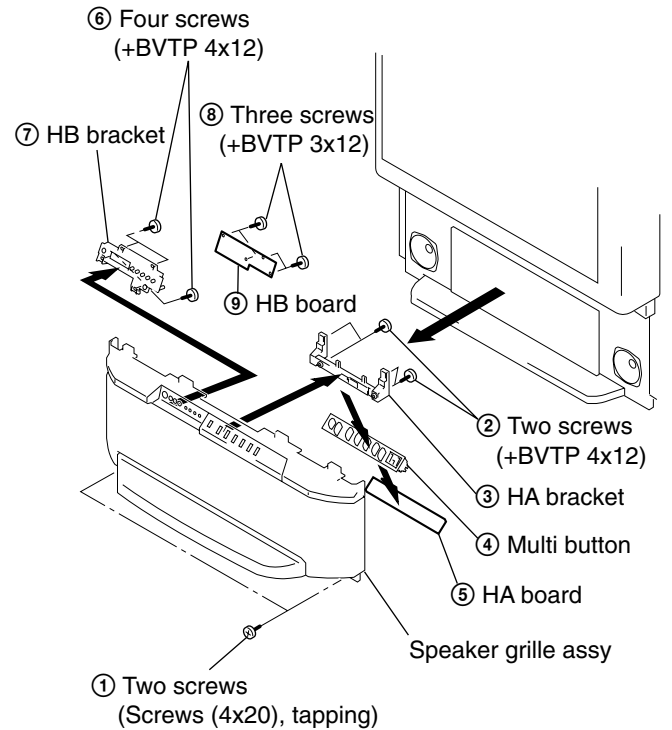

**2-5. HA, HB AND FB BOARD REMOVAL
 (KP-43T75A)**

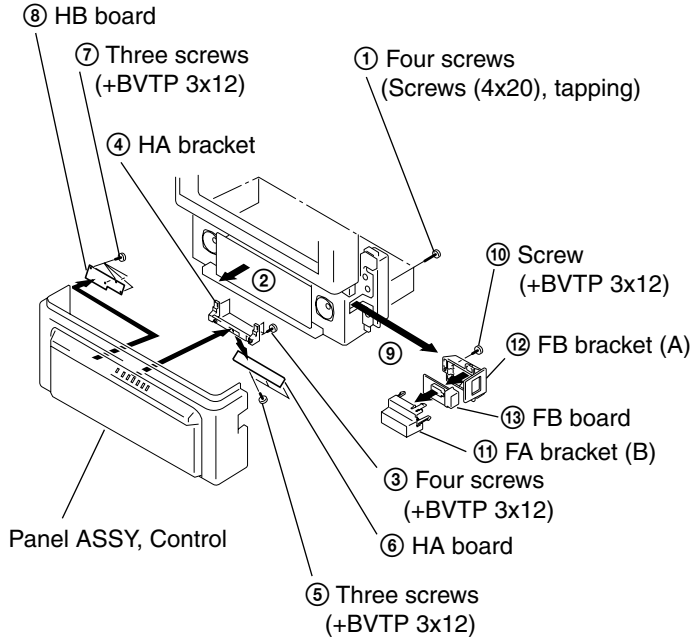

2-6. MIRROR COVER REMOVAL

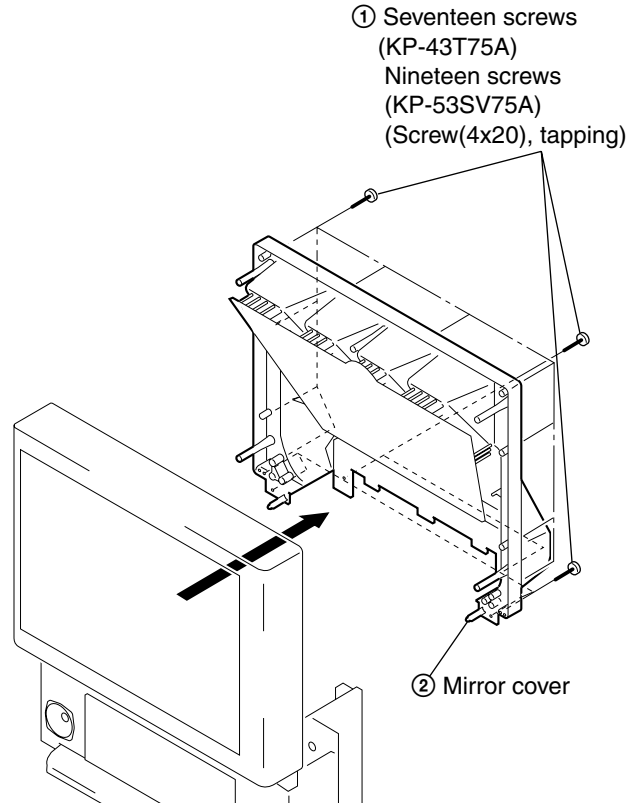

**2-7. BEZNET ASSY AND
 FB BOARD (KP-53SV75A) REMOVAL**

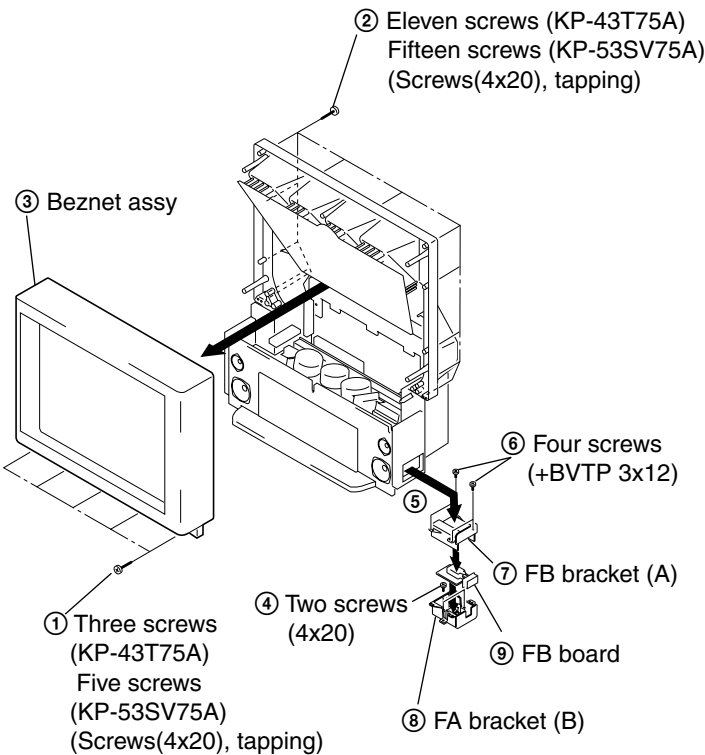

2-8. HC BOARD AND S BOARD REMOVAL

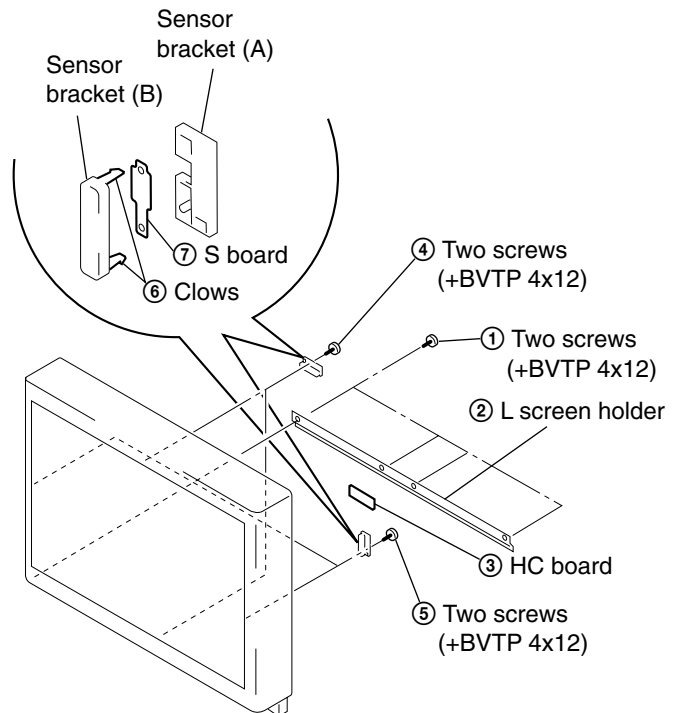

2-9. A, G AND FA BOARDS REMOVAL

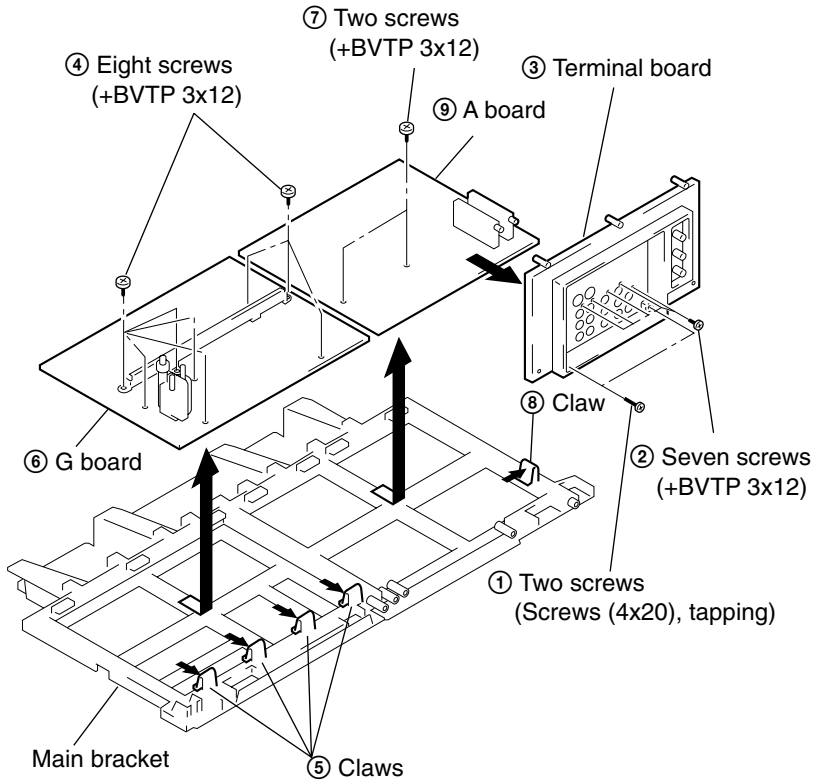

2-11. HIGH-VOLTAGE CABLE INSTALLATION AND REMOVAL

(1) Removal

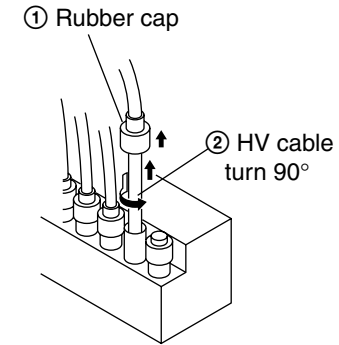

(2) Installation

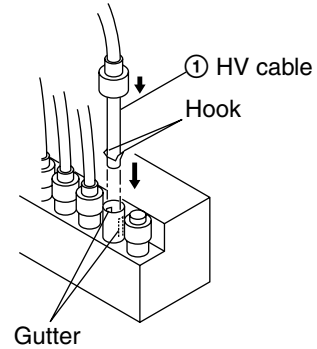

2-10. PICTURE TUBE REMOVAL

CAUTION: Removing the arrow-marked screws is strictly prohibited. If removed, it may cause liquid spill.

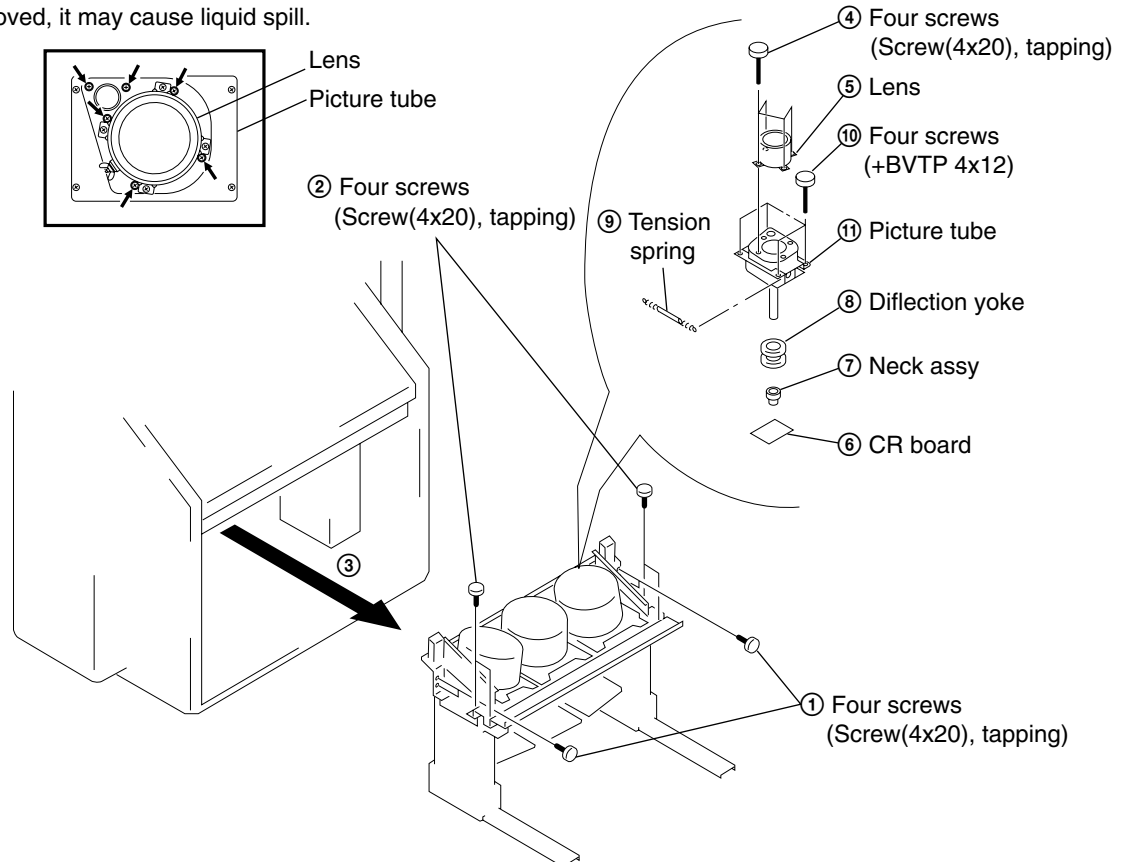

SECTION 3 SET-UP ADJUSTMENTS

3-1. SCREEN VOLTAGE ADJUSTMENT (COARSE ADJUSTMENT)

1. Receive the Monoscope signal.
2. Set 50% BRIGHTNESS and minimum PICTURE.
3. Turn the red VR on the FOCUS block all the way to the left and then gradually turn it to the right until the point where you can see the retrace line.
4. Next gradually turn it to the left to the position where the retrace line disappears.

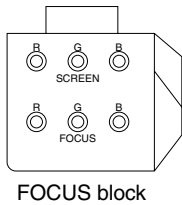

Fig. 3-1

3-2. SCREEN (G2) ADJUSTMENT (FINE ADJUSTMENT)

Fine Mode is recommended to set screen controls to their optimal condition. It is necessary to build the simple jig, illustrated below, using 3-watt resistors. Please note, that if the proper voltage is not obtained with their listed values, resistors, then please increase or decrease one of the values in the resistor network to obtain the correct voltage.

1. Select VIDEO1 mode without signals.
2. Connect G2 JIG.
3. SW on JIG.
4. Connect an oscilloscope to the TP701(KR), TP732(KG) and TP761(KB) of CR board, CG board and CB board.
5. Adjust R, G and B screen voltage to 168-172V with screen VR on the Focus block.

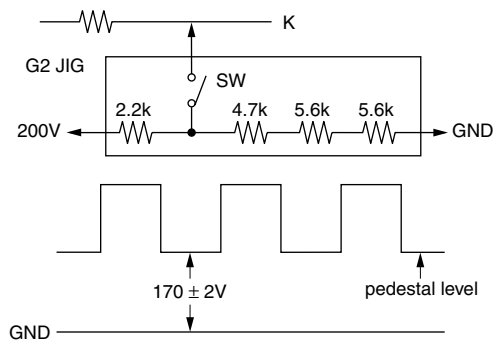

Fig. 3-2

3-3. DEFLECTION YOKE TILT ADJUSTMENT

1. Receive the Monoscope signal.
2. Set in service mode.
3. Cover the both red and blue picture lenses with the lens caps to show only the green color.
4. Loosen the deflection yoke set screw and align the tilt of the Deflection Yoke so that the bars at the center of the monoscope pattern are horizontal.
5. After aligning the deflection yoke, fasten it securely to the funnel-shaped portion (neck) of the CRT.
6. The tilt of the deflection yoke for red is aligned in the mode Cover the both green and blue picture lenses with the lens caps and the tilt of the deflection yoke for blue is aligned with in

the mode Cover the both green and red picture lenses with the lens caps is aligned the same as was done for green.

Note: Instead of items 3 and 6, you can cut off the unnecessary color beams by controlling the service mode VPTR 17 RON, 18 GON, and 19 BON.

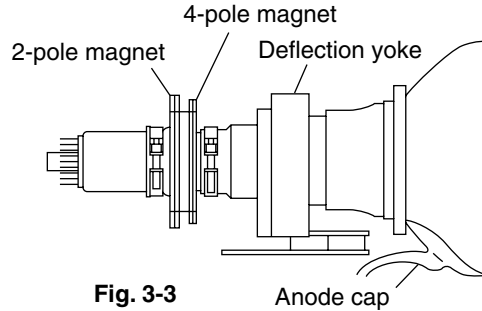

Fig. 3-3

3-4. FOCUS LENS ADJUSTMENT

In this adjustment, use the remote commander in the service mode.

For details of the usage of the service mode and the remote commander, please refer the item 3-9. ELECTRICAL ADJUSTMENT BY REMOTE COMMANDER.

1. Loosen the lens screw.
2. Set to the service mode.
3. Receive the all-white signal.
4. Cover the both red and blue picture lenses with the lens caps to show only the green color.
5. Set to PJE, and press 6 to display the test signal (crosshatch)** on the screen.
6. Turn the green lens to adjust to the optimum focus point with the test signal.
7. Tighten the lens screw.
8. Cover the both green and blue picture lenses with the lens caps to show only the red color.
9. Set to PJE, and press 6 to display the test signal (crosshatch)** on the screen.
10. Adjust red CRT lens just the same as green.
11. Cover the both green and red picture lenses with the lens caps to show only the blue color.

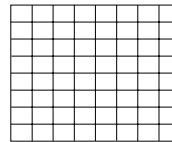

Test signal

Fig. 3-4

12. Set to PJE, and press 6 to display the test signal (crosshatch)** on the screen.
13. Adjust blue CRT lens just the same as green.
14. After adjusting the items 3-5. Focus VR Adjustment, 3-6. 2-Pole Magnet Adjustment and 3-7. 4-Pole Magnet Adjustment, adjust again to the optimum focus point.

*: Every time you press 6, the test signal changes to "crosshatch+video signal" - "dots+video signal" - "crosshatch(black)" - "dots(black)" - off.

Note: Instead of items 4, 8 and 11, you can cut off the unnecessary color beams by controlling the service mode VPTR 17 RON, 18 GON, and 19 BON.

3-5. FOCUS VR ADJUSTMENT

1. Set to the service mode.
2. Receive the all-white signal.
3. Cover the both red and blue picture lenses with the lens caps to show only the green color.
4. Set to PJE, and press 6 to display the test signal (crosshatch) on the screen.
5. Turn the green focus VR on the focus block to adjust to the optimum focus point with the test signal.
6. Cover the both green and blue picture lenses with the lens caps to show only the red color.
7. Set to PJE, and press 6 to display the test signal (crosshatch) on the screen.
8. Turn the red focus VR on the focus block to adjust to the optimum focus point with the test signal.
9. Cover the both green and red picture lenses with the lens caps to show only the blue color.
10. Set to PJE, and press 6 to display the test signal (crosshatch) on the screen.
11. Turn the blue focus VR on the focus block to adjust to the optimum focus point with the test signal.
12. After adjusting the items 3-4. Focus Lens Adjustment, 3-6. 2-Pole Magnet Adjustment and 3-7. 4-Pole Magnet Adjustment, adjust again to the optimum focus point.

Note: Instead of items 3, 6 and 9, you can cut off the unnecessary color beams by controlling the service mode VPTR 17 RON, 18 GON, and 19 BON.

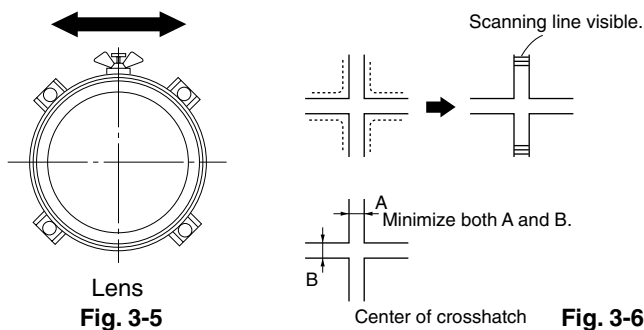

3-6. 2-POLE MAGNET ADJUSTMENT (GREEN, RED)

1. Receive the Dot signal.
2. Set in service mode.
3. Cover the both red and blue picture lenses with the lens caps to show only the green color.
4. Turn the green focus VR on the focus block to the right and set to overfocus to enlarge the spot.
5. Now align the 2-Pole Magnet so that the enlarged spot is in the center of the Just Focus spot.
6. Align the green focus VR and set for just (precise) focus.
7. Perform the same alignment for red.

Use the center dot

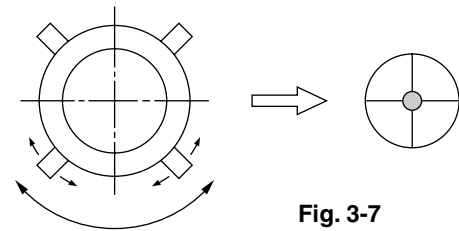

Fig. 3-7

3-7. 4-POLE MAGNET ADJUSTMENT

1. Receive the Dot signal.
2. Set in service mode.
3. Cover the both red and blue picture lenses with the lens caps to show only the green color.
4. Turn the green focus VR on the focus block to the left and set to underfocus to enlarge the spot.
5. Now align the 4-Pole Magnet so that the enlarged spot becomes a perfect circle for green and red.
6. Perform the same alignment for blue.

Use the center dot

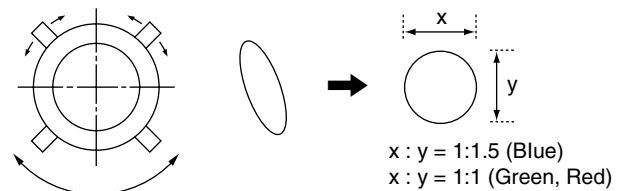

Fig. 3-8

3-8. DEFOCUS ADJUSTMENT (BLUE)

Note: Please adjust the blue dot to be slightly larger than red and green dots. This adjustment provides a more pleasing picture to the customer.

1. Select the video menu and set the mode to "VIVID" mode.
2. Set to the service mode.
3. Change TV mode to the video input mode.
4. Set to PJE, and press 6 to display the test signal (dots) on the screen.
5. Turn the blue focus VR on the focus block to adjust to the diameter of the dots as shown in the figure below.

[Focus adjustment point]

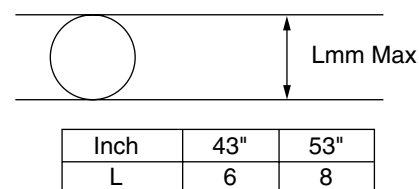

Fig. 3-9

3-9. ELECTRICAL ADJUSTMENT BY REMOTE COMMANDER

By using Remote Commander (RM-Y906), all circuit adjustments can be made.

NOTE : Test Equipment Required.

1. Pattern Generator (with component outputs)
2. Frequency counter
3. Digital multimeter
4. Audio oscillator

1. METHOD OF SETTING THE SERVICE ADJUSTMENT MODE

SERVICE MODE PROCEDURE

1. Standby mode. (Power off)
2. **DISPLAY** → **5** → **VOL (+)** → **TV POWER** on the Remote Commander.
(Press each button within a second.)

SERVICE MODE ADJUSTMENT

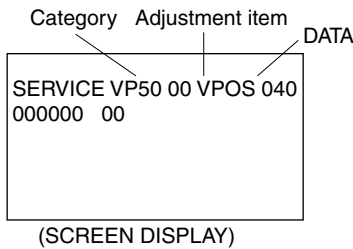

3. The SCREEN displays the item being adjusted.
4. Press **1** or **4** on the Remote Commander to select the adjustment item.
5. Press **3** or **6** on the Remote Commander to change the data.
6. Press **2** or **5** on the Remote Commander to select the category.

Every time you press 2(Category up), Service mode changes in the order as shown below.

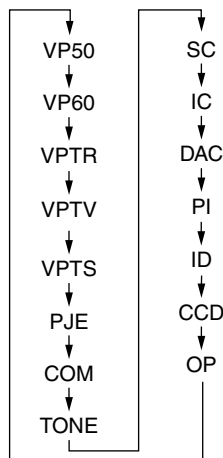

7. If you want to recover the latest values press **0** then **ENTER** to read the memory.
8. Press **MUTING** then **ENTER** to write into memory.
9. Turn power off.

Note: Press **8** then **ENTER** on the Remote Commander to initialize or turn set off and on to exit.

2. MEMORY WRITE CONFIRMATION METHOD

1. After adjustment, remove the plug from AC outlet, and then replace the plug in AC outlet again.
2. Turn the power switch ON and set to Service Mode.
3. Call the adjusted items again and confirm they were adjusted.

3. ADJUSTING BUTTONS AND INDICATOR

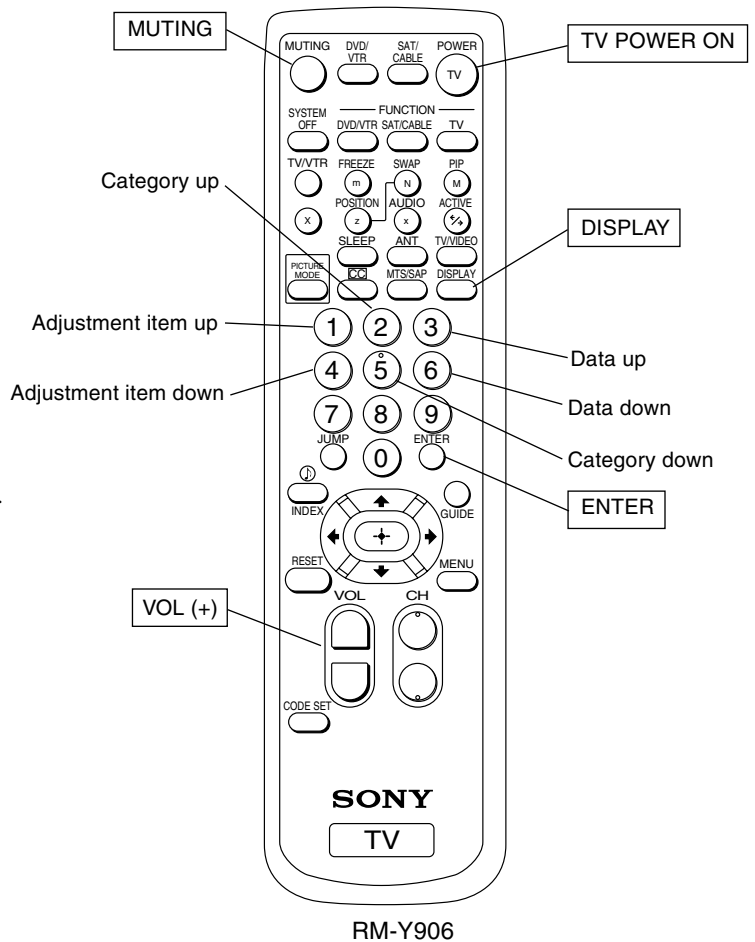

Note : When the PJE mode is activated, which displays an internally generated signal, several buttons on the remote commander will have different functions than listed above. Therefore, when in the PJE mode, refer to page 9 for button functions.

4. SERVICE MODE LIST

Note: • shaded items are fixed. There is no need to change data. Others are different a little in the sets individually. Basically, there is no need to change data, too.

- Usually, there is no need to adjust except for VP and PJE. Use data as a reference in case of replacing printed circuit boards or devices.

VP (Video Processor)

VP50 (For PAL-N)

ITEM NUMBER	ADJUSTMENT ITEM	DATA RANGE	STANDARD DATA	NOTE
0	VPOS	0-63	40	V POSITION
1	VSIZ	0-63	2	V SIZE
2	VCOM	0-15	0	V COMP
3	VLIN	0-15	8	V LINEARITY
4	VSCO	0-15	7	V SCURVE CORRECTION
5	HPOS	0-63	25	H POSITION
6	HSIZ	0-63	11	H SIZE
7	PAMP	0-63	37	PIN AMP
8	UPIN	0-63	40	UPPER CORNER PIN DISTORTION
9	LPIN	0-63	38	LOWER CORNER PIN DISTORTION
10	PPHA	0-15	7	PIN PHASE
11	VBOW	0-15	7	V BOW
12	VANG	0-15	5	V ANGLE
13	AFC	0-3	0	AFC LOOP GAIN

VP60 (For NTSC)

ITEM NUMBER	ADJUSTMENT ITEM	DATA RANGE	STANDARD DATA	NOTE
0	VPOS	0-63	36	V POSITION
1	VSIZ	0-63	5	V SIZE
2	VCOM	0-15	0	V COMP
3	VLIN	0-15	7	V LINEARITY
4	VSCO	0-15	7	V SCURVE CORRECTION
5	HPOS	0-63	20	H POSITION
6	HSIZ	0-63	2	H SIZE
7	PAMP	0-63	32	PIN AMP
8	UPIN	0-63	35	UPPER CORNER PIN DISTORTION
9	LPIN	0-63	42	LOWER CORNER PIN DISTORTION
10	PPHA	0-15	5	PIN PHASE
11	VBOW	0-15	7	V BOW
12	VANG	0-15	6	V ANGLE
13	AFC	0-3	0	AFC LOOP GAIN

VPTR (Video Processor NTSC /PAL-N)

ITEM NUMBER	ADJUSTMENT ITEM	DATA RANGE	STANDARD DATA	NOTE
0	REFP	0, 1	0	REFERENCE PULSE POSITION
1	RDRV	0-63	41	RED DRIVE GAIN
2	GDRV	0-63	34	GREEN DRIVE GAIN
3	BDRV	0-63	22	BLUE DRIVE GAIN
4	RCUT	0-15	7	RED CUTOFF
5	GCUT	0-15	7	GREEN CUTOFF
6	BCUT	0-15	9	BLUE CUTOFF
7	SHUE	0-63	32	SUB HUE
8	SCOL	0-63	27	SUB COLOR
9	CDMD	0-63	1	COUNT DOWN MODE
10	HOSC	0-15	8	H VCO OSCILLATION FREQUENCY
11	HSS	0, 1	0	H SYNC SLICE LEVEL
12	VSS	0, 1	0	V SYNC SLICE LEVEL
13	INCR	0-3	0	INTERLACE MODE
14	PINP	0, 1	1	SHAPNESS F0
15	ALTH	0, 1	1	ABL CONTROL SIGNAL DETECTION LEVEL
16	HMSC	0, 1	1	MACRO VISION COUNTERMEASURE
17	RON	0, 1	1	RED ON
18	GON	0, 1	1	GREEN ON
19	BON	0, 1	1	BLUE ON
20	DCOL	0, 1	1	DYNAMIC COLOR
21	LBLK	0-15	15	LEFT-SIDE BLANK WIDTH
22	RBLK	0-15	0	RIGHT-SIDE BLANK WIDTH
23	YDLY	0-15	7	Y DELAY
24	PREC	0, 1	1	PRE OVER LEVEL FOR COMP. V IN
25	PREY	0, 1	0	PRE OVER LEVEL FOR Y IN
26	CBPF	0, 1	0	CHROMA BAND PASS FILTER

VPTV (Video Processor Vivid)

ITEM NUMBER	ADJUSTMENT ITEM	DATA RANGE	STANDARD DATA	NOTE
0	SBRV	0-63	42	SUB BRIGHTNESS FOR VIVID
1	GMMV	0-3	1	GAMMA LEVEL FOR VIVID
2	YDCV	0, 1	1	Y-DC TRANSFER RATIO FOR VIVID
3	ABLV	0, 1	0	ABL MODE FOR VIVID
4	AXIV	0, 1	0	AXIS R-Y,G-Y FOR VIVID
5	VMLV	0-3	3	VM LEVEL FOR VIVID

VPTS (Video Processor Standard)

ITEM NUMBER	ADJUSTMENT ITEM	DATA RANGE	STANDARD DATA	NOTE
0	SBRS	0-63	42	SUB BRIGHTNESS FOR STANDARD
1	GMMS	0-3	0	GAMMA LEVEL FOR STANDARD
2	YDCS	0, 1	0	Y-DC TRANSFER RATIO FOR STANDARD
3	ABLS	0, 1	1	ABL MODE FOR STANDARD
4	AXIS	0, 1	0	AXIS R-Y,G-Y FOR STANDARD
5	VMLS	0-3	3	VM LEVEL FOR STANDARD

PJE (Projection TV Engine) (For PAL-N)

ITEM NUMBER	ADJUSTMENT ITEM	DATA RANGE	STANDARD DATA	NOTE
0	FDIS	0,1	0	SELECT REGI DATA DISPLAY OF FINE ADJ
1	OSDH	1-255	31	PJED SERVICE MENU H POSITION
2	OSDV	1-255	25	PJED SERVICE MENU V POSITION
3	FVST	0-255	35	LINE NUMBER OF FINE ADJUST START
4	V1ST	0-255	0	V1 START DATA
5	V1CU	0-255	52	V1 COUNT UP DATA
6	COHP	0-255	0	H-PHASE OF ROUGH ADJ
7	FIHP	0-255	194	H-PHASE OF FINE ADJ
8	TPHP	0-255	62	H-PHASE OF TEST PATTERN
9	DFHP	0-255	225	H-PHASE OF DYNAMIC FOCUS
10	DFHG	-128-127	-80	H-2 GAIN OF DYNAMIC FOCUS
11	DFVG	-128-127	-30	V-2 GAIN OF DYNAMIC FOCUS
12	PWM 1	0-255	0	PWM 1
13	PWM2	0-255	31	H-PHASE OF AUTO REGI .TEST PATTERN
14	HBLD	0-255	238	H-PHASE OF RETURNED BLUE V LINE
15	HBLW	0-255	23	PULSE WIDTH OF RETURNED BLUE V LINE
16	BLKP	0-255	27	START BLANK PULSE
17	COGV	-128-127	X(*1)	GREEN V CENT OFFSET DATA OF AUTO REGI
18	CORV	-128-127	X(*1)	RED V CENT OFFSET DATA OF AUTO REGI
19	COBV	-128-127	X(*1)	BLUE V CENT OFFSET DATA OF AUTO REGI
20	COGH	-128-127	X(*1)	GREEN H CENT OFFSET DATA OF AUTO REGI
21	CORH	-128-127	X(*1)	RED H CENT OFFSET DATA OF AUTO REGI
22	COBH	-128-127	X(*1)	BLUE H CENT OFFSET DATA OF AUTO REGI
23	SOGV	-128-127	X(*1)	GREEN V SKEW OFFSET DATA OF AUTO REGI
24	SORV	-128-127	X(*1)	RED V SKEW OFFSET DATA OF AUTO REGI
25	SOBV	-128-127	X(*1)	BLUE V SKEW OFFSET DATA OF AUTO REGI
26	SOGH	-128-127	X(*1)	GREEN H SKEW OFFSET DATA OF AUTO REGI
27	SORH	-128-127	X(*1)	RED H SKEW OFFSET DATA OF AUTO REGI
28	SOBH	-128-127	X(*1)	BLUE H SKEW OFFSET DATA OF AUTO REGI
29	ERR	FIXED	0	AUTO REGI ERROR CODE
30	ADTM	0-255	144	TIMING TO GET A/D DATA OF AUTO REGI
31	VUP	0-255	6	AUTO REGI PATTERN UPPER V POSITION
32	VMID	0-255	133	AUTO REGI PATTERN MIDDLE V POSITION
33	VLOW	0-255	260	AUTO REGI PATTERN LOWER V POSITION
34	HPR	0-510	1	AUTO REGI PATTERN H POSITION
GRN	CENT	-512-511	062 / 016	GREEN H/V CENT
	SKEW	-512-511	042 / 079	GREEN H/V SKEW
	SIZE	-512-511	035 /-136	GREEN H/V SIZE
	LIN	-512-511	xxxx / xxxx	GREEN H/V LIN
	KEY	-512-511	xxxx / xxxx	GREEN H/V KEY
	PIN	-512-511	xxxx / 220	GREEN H/V PIN
BLU	CENT	-512-511	-002 / -104	BLUE H/V CENT
	SKEW	-512-511	074 / -036	BLUE H/V SKEW
	SIZE	-512-511	119 / -121	BLUE H/V SIZE
	LIN	-512-511	-166 / xxxx	BLUE H/V LIN
	KEY	-512-511	xxxx / -112	BLUE H/V KEY
	PIN	-512-511	xxxx / 161	BLUE H/V PIN
RED	CENT	-512-511	022 / 004	RED H/V CENT
	SKEW	-512-511	-061 / 098	RED H/V SKEW
	SIZE	-512-511	013 / -127	RED H/V SIZE
	LIN	-512-511	025 / 117	RED H/V LIN
	KEY	-512-511	xxxx / 117	RED H/V KEY
	PIN	-512-511	xxxx / 234	RED H/V PIN

* 1 : Set correctly by the automatic restritation adjustment.

xxxx : Cannot change.

PJE (Projection TV Engine) (For NTSC)

ITEM NUMBER	ADJUSTMENT ITEM	DATA RANGE	STANDARD DATA	NOTE
0	FDIS	0,1	0	SELECT REGI DATA DISPLAY OF FINE ADJ
1	OSDH	1-255	31	PJED SERVICE MENU H POSITION
2	OSDV	1-255	25	PJED SERVICE MENU V POSITION
3	FVST	0-255	29	LINE NUMBER OF FINE ADJUST START
4	V1ST	0-255	0	V1 START DATA
5	V1CU	0-255	62	V1 COUNT UP DATA
6	COHP	0-255	0	H-PHASE OF ROUGH ADJ
7	FIHP	0-255	194	H-PHASE OF FINE ADJ
8	TPHP	0-255	62	H-PHASE OF TEST PATTERN
9	DFHP	0-255	225	H-PHASE OF DYNAMIC FOCUS
10	DFHG	-128-127	-80	H-2 GAIN OF DYNAMIC FOCUS
11	DFVG	-128-127	-30	V-2 GAIN OF DYNAMIC FOCUS
12	PWM 1	0-255	0	PWM 1
13	PWM2	0-255	30	H-PHASE OF AUTO REGI .TEST PATTERN
14	HBLD	0-255	238	H-PHASE OF RETURNED BLUE V LINE
15	HBLW	0-63	23	PULSE WIDTH OF RETURNED BLUE V LINE
16	BLKP	0-255	27	START BLANK PULSE
17	COGV	-128-127	X(*1)	GREEN V CENT OFFSET DATA OF AUTO REGI
18	CORV	-128-127	X(*1)	RED V CENT OFFSET DATA OF AUTO REGI
19	COBV	-128-127	X(*1)	BLUE V CENT OFFSET DATA OF AUTO REGI
20	COGH	-128-127	X(*1)	GREEN H CENT OFFSET DATA OF AUTO REGI
21	CORH	-128-127	X(*1)	RED H CENT OFFSET DATA OF AUTO REGI
22	COBH	-128-127	X(*1)	BLUE H CENT OFFSET DATA OF AUTO REGI
23	SOGV	-128-127	X(*1)	GREEN V SKEW OFFSET DATA OF AUTO REGI
24	SORV	-128-127	X(*1)	RED V SKEW OFFSET DATA OF AUTO REGI
25	SOBV	-128-127	X(*1)	BLUE V SKEW OFFSET DATA OF AUTO REGI
26	SOGH	-128-127	X(*1)	GREEN H SKEW OFFSET DATA OF AUTO REGI
27	SORH	-128-127	X(*1)	RED H SKEW OFFSET DATA OF AUTO REGI
28	SOBH	-128-127	X(*1)	BLUE H SKEW OFFSET DATA OF AUTO REGI
29	ERR	FIXED	0	AUTO REGI ERROR CODE
30	ADTM	0-255	144	TIMING TO GET A/D DATA OF AUTO REGI
31	VUP	1-255	1	AUTO REGI PATTERN UPPER V POSITION
32	VMID	1-255	104	AUTO REGI PATTERN MIDDLE V POSITION
33	VLOW	1-255	212	AUTO REGI PATTERN LOWER V POSITION
34	HPR	1-510	1	AUTO REGI PATTERN H POSITION
GRN	CENT	-512-511	008 / 030	GREEN H/V CENT
	SKEW	-512-511	-068 / 086	GREEN H/V SKEW
	SIZE	-512-511	-094/-156	GREEN H/V SIZE
	LIN	-512-511	xxxx / xxxx	GREEN H/V LIN
	KEY	-512-511	xxxx / xxxx	GREEN H/V KEY
	PIN	-512-511	xxxx / 222	GREEN H/V PIN
BLU	CENT	-512-511	-029 / -134	BLUE H/V CENT
	SKEW	-512-511	024 / 073	BLUE H/V SKEW
	SIZE	-512-511	-37 / -129	BLUE H/V SIZE
	LIN	-512-511	-119 / xxxx	BLUE H/V LIN
	KEY	-512-511	xxxx / -114	BLUE H/V KEY
	PIN	-512-511	xxxx / 129	BLUE H/V PIN
RED	CENT	-512-511	010 / -053	RED H/V CENT
	SKEW	-512-511	-115 / 061	RED H/V SKEW
	SIZE	-512-511	-095 / -052	RED H/V SIZE
	LIN	-512-511	048 / xxxx	RED H/V LIN
	KEY	-512-511	xxxx / 108	RED H/V KEY
	PIN	-512-511	xxxx / 222	RED H/V PIN

* 1 : Set correctly by the automatic restritation adjustment.

xxxx : Cannot change.

COM (Comb Filter)

ITEM NUMBER	ADJUSTMENT ITEM	DATA RANGE	STANDARD DATA	NOTE
0	THRH	0, 1	0	THROUGH MODE
1	VENH	0-7	3	V EMPHASIS
2	PDS	0, 1	0	PEDESTAL CLIP
3	VNLR	0-15	7	EMPHASIS
4	GEL	0-3	3	Y PEEKING GAIN SELECT
5	CORL	0-3	2	CORING LEVEL
6	CTRP	0-3	2	TRAP LEVEL
7	CBPF	0, 1	0	CHROMA BAND PASS FILTER
8	ADMD	0-3	0	AD/DA MODE
9	DIZI	0, 1	0	C UP CONVERT

TONE (Tone Control)

() : 53SV75A

ITEM NUMBER	ADJUSTMENT ITEM	DATA RANGE	STANDARD DATA	NOTE
0	RBAS	0-63	38	RESET VALUE OF USER BASS DATA
1	RTRE	0-63	32 (31)	RESET VALUE OF USER TREBLE DATA
2	BBEH	0-15	10	BBE HIGH FREQUENCY
3	BBEL	0-11	3 (6)	BBE LOW FREQUENCY
4	LOOP	0, 1	0	LOOP
5	SUFE	0	3	SURROUND EFFECT

SC (Sub Chroma Decoder)

ITEM NUMBER	ADJUSTMENT ITEM	DATA RANGE	STANDARD DATA	NOTE
0	SYDR	0-31	21	SUB Y DRIVE
1	SSHU	0-63	-	SUB SUB HUE
2	SSCL	0-63	29	SUB SUB COLOR
3	SUPD	0-15	7	SUB U PEDESTAL OFFSET
4	SVPD	0-15	7	SUB V PEDESTAL OFFSET
5	SDLY	0-3	0	SUB Y DELAY
6	SU2P	0-15	7	SUB U2 PEDESTAL OFFSET
7	SV2P	0-15	7	SUB V2 PEDESTAL OFFSET
8	SY2D	0-3	31	SUB Y2 DRIVE
9	SU2D	0-31	18	SUB U2 DRIVE
10	SV2D	0-31	18	SUB V2 DRIVE
11	SPRE	0-3	3	SUB PRE-OVER

IC (Inset Chroma Decoder)

ITEM NUMBER	ADJUSTMENT ITEM	DATA RANGE	STANDARD DATA	NOTE
0	PCDR	0-15	1	PIP COLOR
1	PHDR	0-15	7	PIP HUE
2	PAFC	0-3	2	PIP AFC LOOP GAIN
3	PTAD	0-15	7	PIP TRAP F0 ADJUSTMENT
4	PTOT	0,1	0	PIP CHROMA TOT FILTER
5	PSCN	0-15	13	PIP SUB CONTRAST
6	PYDC	0-7	0	PIP Y DC TRAN
7	PSHP	0,1	1	PIP SHARPNESS F0
8	PMSK	0,1	0	PIP MACRO VISION MASK

DAC (D/A Converter)

ITEM NUMBER	ADJUSTMENT ITEM	DATA RANGE	STANDARD DATA	NOTE
0	UVSH	0-63	31	YUV SUB HUE
1	UVSC	0-63	39	YUV SUB COLOR

PI (Picture In Picture)

ITEM NUMBER	ADJUSTMENT ITEM	DATA RANGE	STANDARD DATA	NOTE
0	PIPH	0-255	95	PIP H POSITION FOR NTSC
1	PIPV	0-255	22	PIP V POSITION FOR NTSC
2	PPH5	0-255	97	PIP H POSITION FOR PAL-N
3	PPV5	0-255	24	PIP V POSITION FOR PAL-N
4	PYSD	0-15	1	PIP SELECT DELAY
5	PYDL	0-7	0	PIP Y DELAY
6	PHDL	0-15	2	H-PULSE DELAY
7	PMVD	0-31	9	MAIN V-PULSE DELAY
8	PIVD	0-31	22	INSET V-PULSE DELAY
9	PCON	0-15	11	INSET CONTRAST
10	FRMY	0-15	7	FRAME Y
11	IPER	0-15	0	PIP PEDESTAL R-Y
12	IPEB	0-15	0	PIP PEDESTAL B-Y
13	PCPS	0,1	0	PIP CLP
14	PCPF	0,1	0	PIP CLP CYCLES
15	PPLL	0-3	0	PIP PLL TIME CONSTANT
16	PVNR	0,1	0	PIP VSP PULSE NOISE REDUCTION

ID (Identification)

ITEM NUMBER	ADJUSTMENT ITEM	DATA RANGE	STANDARD DATA	NOTE
0	SERS	0-3	1	SERIES ID
1	KRST		0	KOREAN STEREO
2	LPWR		1	LAST POWER MEMORY
3	LANG		1	LANGUAGE
4	5ADJ		1	50Hz AUTO-REGI ENABLED

CCD (Closed Caption Decoder)

ITEM NUMBER	ADJUSTMENT ITEM	DATA RANGE	STANDARD DATA	NOTE
0	CCHP	0-63	37	OSD H POSI FOR CC/XDS
1	CCHN	0-63	38	NO FUNCTION

OP (Option)

ITEM NUMBER	ADJUSTMENT ITEM	DATA RANGE	STANDARD DATA	NOTE
0	DISP	0-63	39	OSD H POSITION
1	FW1	0-7	2	FIELD1 WINDOW
2	FW2	0-15	3	FIELD2 WINDOW

3-10. REGISTRATION ADJUSTMENT (PJE)

• FUNCTION OF BUTTONS OF REMOTE COMMANDER FOR PJE MODE.

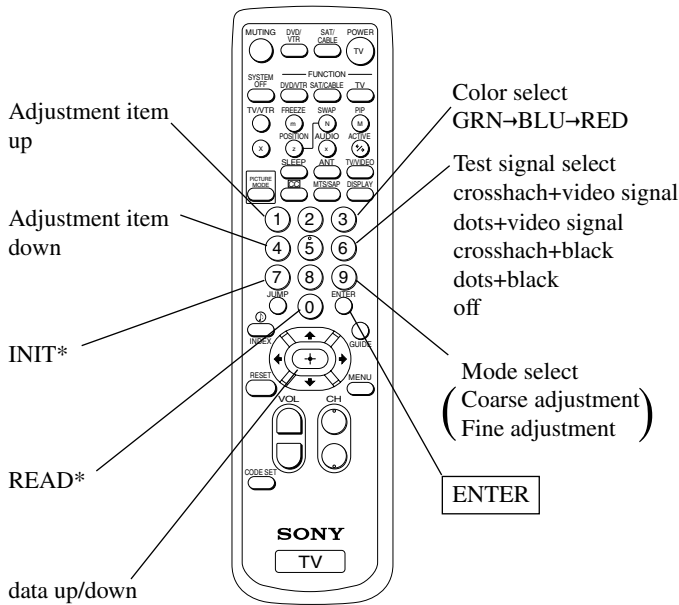

INIT*: Press 7, "INIT" green letters appear on the screen. Then press ENTER, all the PJE data are reset.

READ*: Press 0, "READ" green letters appear on the screen. Then press ENTER, all the PJE default data are restored.

Note: Internal patterns are used for geometry and convergence adjustments. However, sizing and centering must be done with the use of an external generator. The recommended pattern would be a monoscope, or equivalent pattern, which would provide the means to adjust both the linearity and sizing of the picture.

[SETUP FOR ADJUSTMENT]

- Current flow in circuit should be stable before attempting adjustment. So wait 5 minutes after turning on the TV power.
- At the 4 insides of the screen, locate the middle. Use a tape measure to identify the middle.

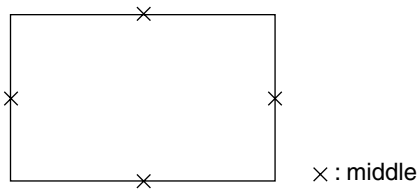

- Separate adjustments are required for multiple modes and should be done in the following order (as each mode requires a separate adjustment) :
 - NTSC mode
 - PAL-N mode

In all these modes, both color convergence and geometry adjustment affects each other.

1. Set to the service mode by pressing quickly keys on the remote commander in the standby mode in the following order:

[DISPLAY] → [5] → [VOL+] → [TV POWER]

2. Change TV mode to the video input mode.
3. Change the VPNT mode to the PJE 00 FDIS.

PJE	00	00
FDIS		

4. Set FDIS data to "01" to display the registration data of each spot in the fine adjustment.

PJE	00	01
FDIS		

5. Press [6] to display the test signal (crosshatch) on the screen.
6. Select GRN CENT(*) with the [1] and [4] keys on the remote commander and check that the adjustment data is now "000" both vertically and horizontally.

	(H)	(V)
GRN	000	000
CENT		

- *: In the factory preset, "GRN CENT" appears on the screen first. In case of other colors "RED" or "BLU", change color by every pressing [3] key.

7. Cover the both red and blue picture lenses with the lens caps to show only the green color.

SUB DEFLECTION ADJUSTMENT ITEM

Adjustment O : Yes - : No

Display	Adjustment item	Adjustment type		
		G	R	B
		H/V	H/V	H/V
CENT	CENT	O/O	O/O	O/O
SKEW	SKEW	O/O	O/O	O/O
SIZE	SIZE	-/-	O/O	O/O
LIN	LIN	-/-	O/-	O/-
KEY	KEY	-/-	-/O	-/O
PIN	PIN	-/O	-/O	-/O

[GREEN REGISTRATION ADJUSTMENT]

<GREEN CENTER>

1. Select GRN CENT [1] and [4] keys on the remote commander.
2. Adjust the center of crosshatch line goes the middle vertically and horizontally (GRN CENT) with the joystick on the remote commander.

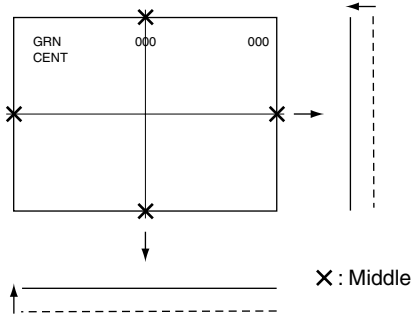

<GREEN SKEW>

1. Select GRN SKEW with the [1] and [4] keys on the remote commander.
2. Adjust the crosshatch line goes straight vertically and horizontally with the joystick on the remote commander.

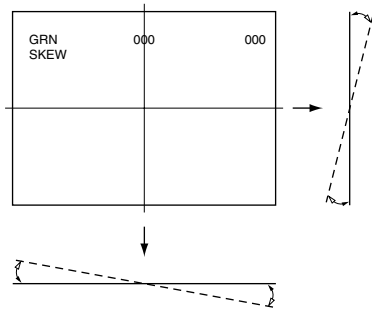

<GREEN PINCUSHION>

1. Select GRN PIN with the [1] and [4] keys on the remote commander.
2. Adjust the crosshatch line goes straight horizontally with the joystick on the remote commander.

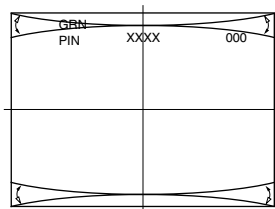

Note : These are required when either severe miss-adjustment or data loss occurred.

<FINE ADJUSTMENT>

1. Press [9] key on the remote commander to shift to the fine adjustment mode.
The green cursor (in the GRN mode) appears on the center of the screen.
2. Use the [1] and [4] keys or the joystick on the remote commander, move the cursor (see below) everywhere you want to adjust and adjust with the joystick keys on the remote commander.

Marker movement by the [1] and [4] keys:

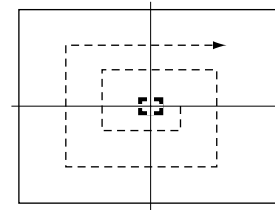

Press once the joystick the cursor turns green to white.

Then you can move the cursor up and down left and right everywhere you want.

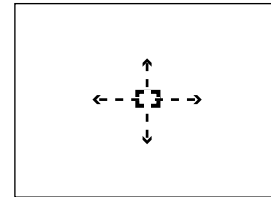

Press once the joystick the cursor stops and returns green, you can adjust around the cursor.

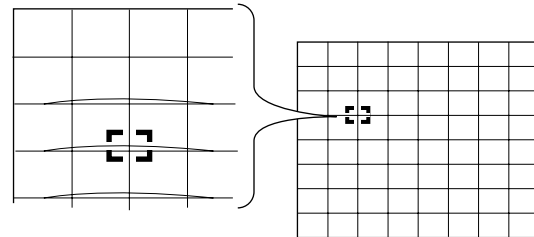

3. Press [9] key on the remote commander to shift to the coarse adjustment mode.

[RED REGISTRATION ADJUSTMENT]

<RED CENTER, SKEW>

1. Cover the blue picture lens with the lens cap to show the green and red colors.
2. Press **[3]** key on the remote commander to shift the GRN mode to the RED mode.
3. Select RED CENT or RED SKEW with the **[1]** and **[4]** keys on the remote commander and adjust while tracking each other alternately.
4. Adjust the red crosshatch lines go straight vertically and horizontally and overlaps the green lines with the joystick on the remote commander.

<RED SIZE, LINEARITY>

1. Select RED SIZE (vertically and horizontally) or RED LIN (vertically) with the **[1]** and **[4]** keys on the remote commander and adjust while tracking each other alternately.
2. Adjust the red crosshatch lines go straight vertically and horizontally and overlaps the green lines with the joystick on the remote commander.

<RED KEY, PINCUSHION>

1. Select RED KEY or PINCUSHION with the **[1]** and **[4]** keys on the remote commander and adjust while tracking each other alternately.
2. Adjust the red crosshatch lines go straight horizontally and overlaps the green lines with the joystick on the remote commander.

Note : These are required when either severe miss-adjustment or data loss occurred.

<FINE ADJUSTMENT>

1. Press **[9]** key on the remote commander to shift to the fine adjustment mode.
The red cursor (in the RED mode) appears on the center of the screen.
2. Use the **[1]** and **[4]** keys or the joystick on the remote commander, move the cursor everywhere you want to adjust and adjust with the joystick on the remote commander.

[BLUE REGISTRATION ADJUSTMENT]

1. Remove the lens cap from the blue picture lens to show full color.
2. Press **[3]** key on the remote commander to shift the RED mode to the BLU mode.
3. Adjust BLU CENT, BLU SKEW, BLU SIZE, BLU LIN, BLU KEY and BLU PIN in the same procedure of the red registration adjustment.

[FINAL CHECK]

1. Store the new adjustment (offset) value on the remote control by pressing **[MUTING]** and **[ENTER]**.
2. Press the FLASH FOCUS button on the front panel.
(The Offset value is now automatically stored.)
3. Check that no error message appears.
If an error message appears, recheck.

Note: In case of replacing CRTs, adjust the set-up adjustments (items 3-1 to 3-8) and the registration adjustment (item 3-10).
In case of replacing two or three CRTs at the same time, replace and adjust one by one.

3-11. AUTO REGISTRATION ERROR CODE LIST

If an error code is displayed after the set has been fully adjusted, correctly, please check the following items: position, tilt and sizing. If either of these adjustments are off, even slightly, the auto-registration pattern will not hit the four sensors properly. This occurs when the internal generator patterns is being flashed on the screen for the sensors to read. Therefore, auto registration (called auto-focus) cannot operate properly causing an error code to be displayed. In order for this function to operate properly, correct position, tilt and size must be adjusted properly.

[ERROR CODE LIST]

ERROR CODE	DISCRIPTION	NOTE
00	No Error	
10	Sensor Output Level Low	* Check wiring, beam position, sensor. 0 : Upper Center 1 : Middle Left 2 : Middle Right 3 : Lower Center
20	Sensor Output Level High	* Check OP-amp circuit. 0 : Upper Center 1 : Middle Left 2 : Middle Right 3 : Lower Center
30	Adjustment Loop Counter Overflow	* Check the registring information on the convergence board.
40	Regi Data Overflow	* Check the convergence yoke driver ICs. * Convergence patterns displayed are out of normal range.
50	Regi Data Overflow	
60	Offset Overflow	
70	Offset Overflow	

* In case of multiple error, last error is displayed.

• ERROR CODE SCREEN DISPLAY

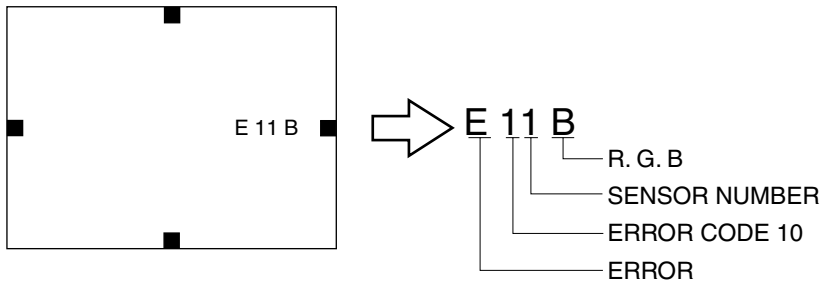

[SENSOR POSITION]

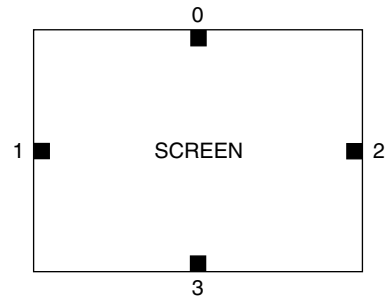

- 0 : UPPER SENSOR
- 1 : LEFT SENSOR
- 2 : RIGHT SENSOR
- 3 : LOWER SENSOR

* Error code will be displayed on center of screen.

• ERROR CODE DISPLAY IN REGI SERVICE MODE

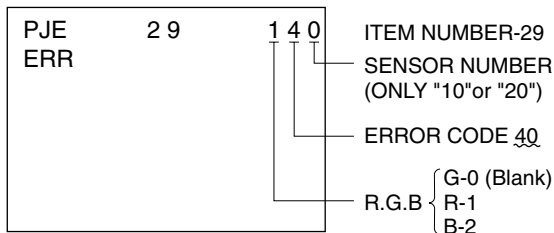



SECTION 4

SAFETY RELATED ADJUSTMENTS

[G BOARD]

4-1. HV REGULATION CIRCUIT CHECK AND ADJUSTMENT

When replacing the following components marked with  on the schematic diagram always check HV regulation, and if necessary re-adjust.

 : C517

 : C517, C521, C522

IC654, L504

T502, T504 (FBT)

D.Y, A board, G board

OPERATION CHECK

1. Connect a HV static voltmeter to the unconnected plug of the high-voltage block. (Fig.4-1)
2. Power on the set.
3. Receive the dot signal. (PICTURE and BRIGHTNESS to minimum)
4. Check that the HV static voltmeter is reading $31.00^{+0.95}_{-1.45}$ kVdc.

HV Regulation adjustment

1. Connect a HV static voltmeter to the unconnected plug of the high-voltage block.
2. Power on the set.
3. Receive the dot signal. (PICTURE and BRIGHTNESS to minimum)
4. If anode voltage is 31.95kV or higher, replace C517 of 470PF/2kV with that of 680PF/2kV, and check if the voltage is within the standard range.
5. If anode voltage is 29.66kV or lower, replace C517 of 470PF/2kV with that of 100PF/2kV, and check if the voltage is within the standard range.

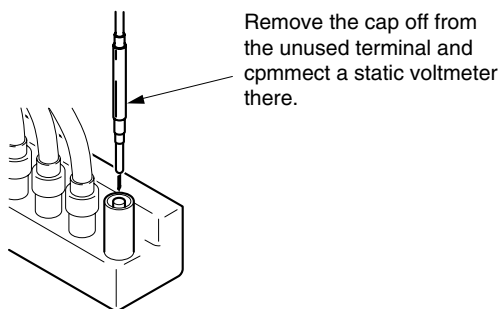





Fig. 4-1

4-2. HV HOLD DOWN CIRCUIT OPERATION CHECK AND ADJUSTMENT

When replacing the following components marked with  on the schematic diagram always check hold-down voltage and if necessary re-adjust.

 : R536, R545

 : C516, C536

D506, D507, D522

IC206, IC502, IC654

L504, R511, R522, R536, R538, R545, R548, R584

T502, T504 (FBT)

D.Y, A board, G board

OPERATION CHECK

1. Remove CN652 connector.
2. Short-circuit across TP-PROT and ground.
3. Connect a HV static voltmeter to the unconnected plug of the high-voltage block.
4. Connect a 220Ω / 200W variable resistor, across pin ② and pin ① of CN652 and connect an external dc power supply unit (200V, class 2A) to pin ③ of CN652.
5. First turn on the external power supply (+B=135V), then turn on the power of the set.
6. Receive the dot signal. (PICTURE and BRIGHTNESS to minimum)
7. Gradually increase the value of the external dc power supply and check that the hold-down circuit operates at a static voltmeter reading of 33.5 ± 0.95 kVdc when the raster disappears.

HV HOLD-DOWN ADJUSTMENT

1. Repeat steps ① ~ ⑦ as above.
2. If hold down voltage is 34.45kV or higher, remove R536, mount a resistor (150kΩ, 1/4W : RN) onto R545 instead, and check again if the hold-down voltage is within the standard range.
3. If hold down voltage is 32.55kV or lower, mount a resistor (220kΩ, 1/4W : RN) onto R536 and check again if the hold-down voltage is within the standard range.

NOTE : Please finish the adjustment as soon as possible

4-3. +B MAX VOLTAGE CONFIRMATION

The following adjustments should always be performed when replacing IC654.

1. Supply 130VAC to with variable autotransformer.
2. Input a dot signal.
3. Set the PICTURE control and the BRIGHTNESS controls to minimum.
4. Confirm the voltage of G BOARD TP135V is less than 137.0Vdc.
5. If step 4 is not satisfied, replace IC654 and repeat above steps.

4-4. +B OVP CONFIRMATION

1. Connect an external dc power supply to TP OVP.
2. Supply 120VAC to variable autotransformer.
3. Set PICTURE and the BRIGHTNESS controls to minimum.
4. Gradually turn the external dc power supply, and check if OVP works properly when the voltage of the external dc power supply is between 139.0 ~ 155.0V.

SECTION 5 CIRCUIT ADJUSTMENTS

5-1. TV INPUT SUB CONTRAST ADJUSTMENT (VPTR-GDRV)

1. Receive the NTSC color-bar (white 75%) signal.
2. Mode : Personal 1 or 2.
PICTURE : maximum
COLOR : minimum
BRIGHTNESS : center
TRINITONE : medium
ABL : CN801 pin ④ open
SERVICE DATA VPTR GDRV : 37
3. Set to service mode.
4. Connect an oscilloscope between pin ⑦ of CN204 (A board) and ground.
5. Select “VPNT-GDRV”, and adjust so that the wave from level is $1.80 \pm 0.05V_{p-p}$.
6. Write the data into memory.

MUTING → ENTER

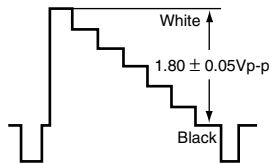

Fig. 5-1

5-2. TV INPUT SUB-HUE AND SUB-COLOR ADJUSTMENT (VPTR-SHUE, SCOL)

1. Receive the NTSC color-bar (white 75%) signal.
2. Mode : Personal 1 or 2.
PICTURE : maximum
COLOR : center
BRIGHTNESS : center
TRINITONE : medium
SERVICE DATA VPTR-SHUE : 32
VPTR-SCOL : 27
3. Set to service mode.
4. Connect an oscilloscope between pin ⑤ of CN204 (A board) connector and ground.
5. Select “VPTR-SHUE, SCOL”, and adjust them to have $VB1 = VB4$ and $VB2 = VB3$ in the waveform levels.
6. Write the data into memory.

MUTING → ENTER

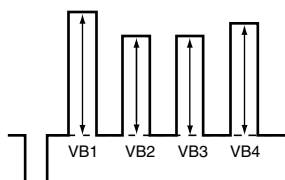

Fig. 5-2

5-3. PIP SUB CONTRAST ADJUSTMENT (SC-SYDR)

1. Receive the signal.
TV terminal (sub) : NTSC color-bar (white 75%)signal
VIDEO terminal (main) : no signal
2. PICTURE : maximum
COLOR : minimum
BRIGHTNESS : center
TRINITONE : medium
ABL : CN801 pin ④ open
SERVICE DATA : SC-SYDR
3. Set to service mode and set to PIP mode.
4. Connect an oscilloscope between pin ⑦ of CN204 (A board) and ground.
5. Select “SC-SYDR”, and adjust so that the wave from level is $1.65 \pm 0.05V_{p-p}$.
6. Write the data into memory.

MUTING → ENTER

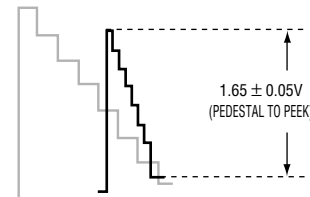

Fig. 5-3

5-4. PIP SUB-HUE, SUB-COLOR ADJUSTMENT (SC-PHDR, SSCL)

1. Receive the signal.
TV terminal (sub) : NTSC color-bar (white 75%)signal
VIDEO terminal (main) : no signal
2. PICTURE : maximum
COLOR : minimum
BRIGHTNESS : center
TRINITONE : medium
ABL : CN801 pin ④ open
SERVICE DATA : SC-PHDR, SSCL
3. Set to service mode and set to PIP mode.
4. Connect an oscilloscope between pin ⑤ of CN204 (A board) and ground.
5. Select “SC-PHDR,SSCL”, and adjust them to have $VB1=VB4$ and $VB2=VB3$ in the wave from levels.
6. Write the data into memory.

MUTING → ENTER

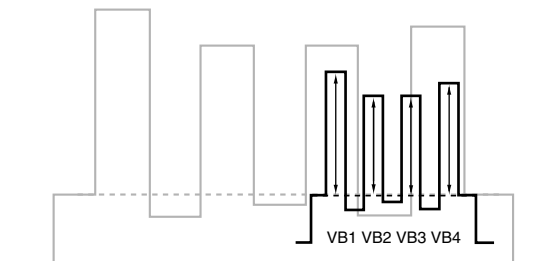

Fig. 5-4

5-5. BAR DISPLAY POSITION ADJUSTMENT (OP-DISP)

1. Receive the NTSC monoscope signal.
2. Set to service mode.
3. Push "PICTURE +". (Bar is displayed)
4. Select "OP-DISP", and adjust so that the bar is as shown in the figure.
5. Write the data into memory.

MUTING → **ENTER**

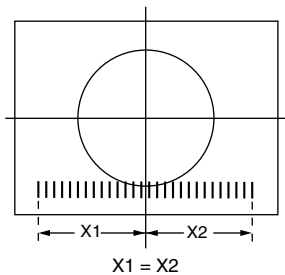

Fig. 5-5

5-6. PIP POSITION ADJUSTMENT (PI-PIPH, PIPV, PPH5, PPV5)

1. Set the PIP mode.
2. Receive the NTSC monoscope signal on the main/sub picture.
3. Check the sub picture position.

$$X1 - X2 \leq 0.25sq$$

$$Y1 - Y2 \leq 0.25sq$$

4. If necessary set to service mode and adjust "PIPH", "PIPV".
5. Write the data into memory.

MUTING → **ENTER**

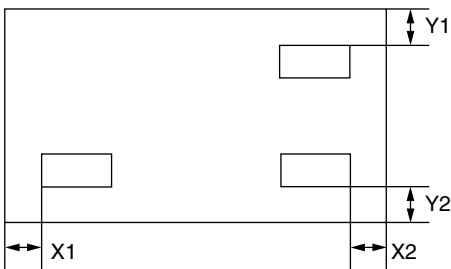

Fig. 5-6

6. Receive the PAL-N monoscope signal on the main/sub picture.
7. Check the sub picture position as specified above.
8. If necessary set to service mode and adjust "PPH5", "PPV5".
9. Write the data into memory.

MUTING → **ENTER**

5-7. TEXT POSITION ADJUSTMENT (CCD-CCHP)

1. Receive RF signal with text.
2. Check the text position.

$$X1 = X2$$

4. If necessary set to service mode and adjust "CCHP".
5. Write the data into memory.

MUTING → **ENTER**

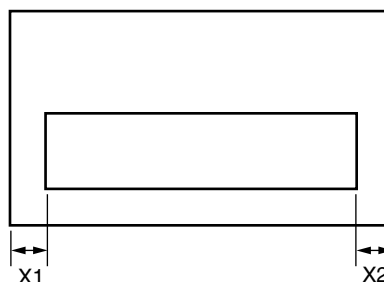
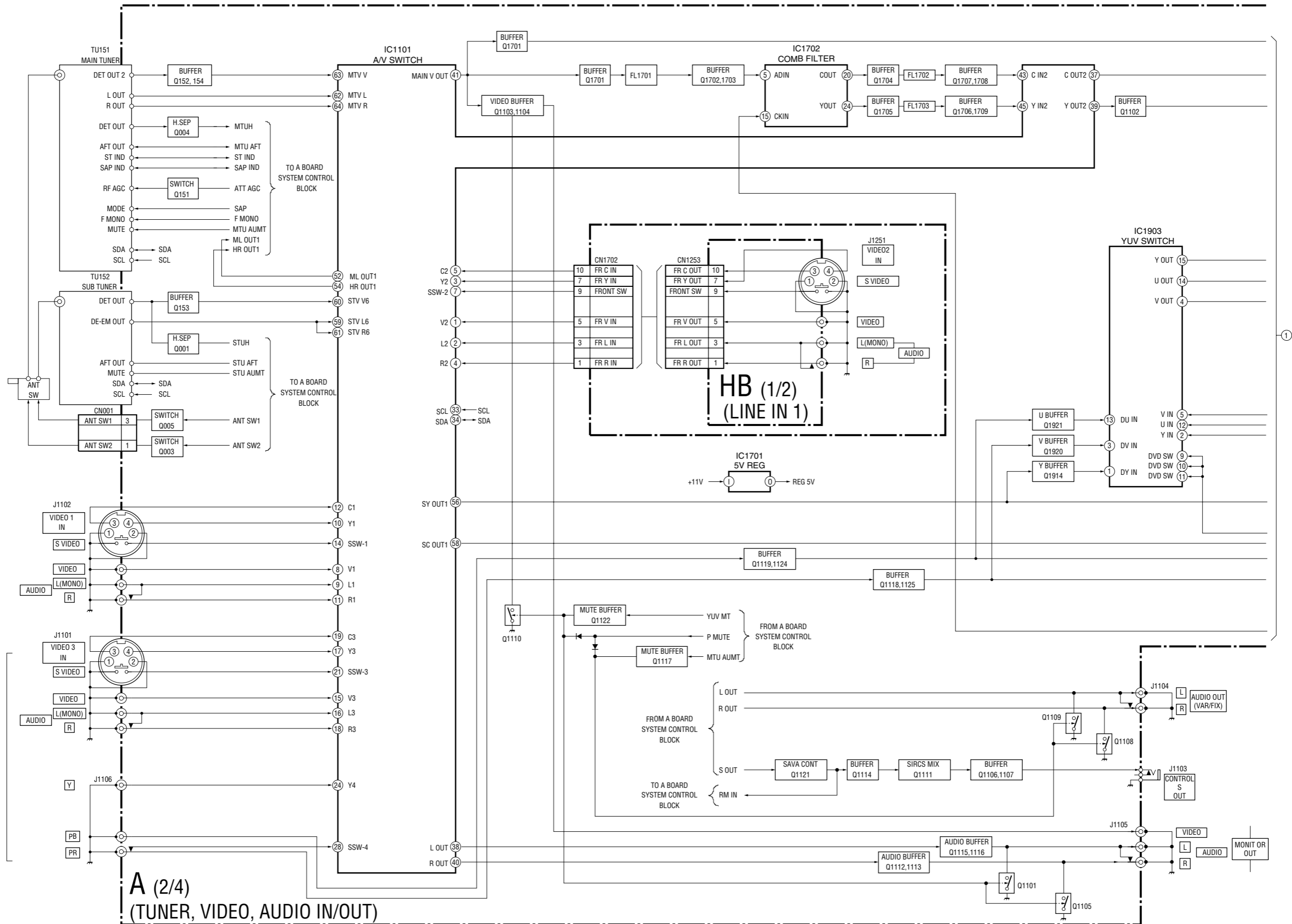
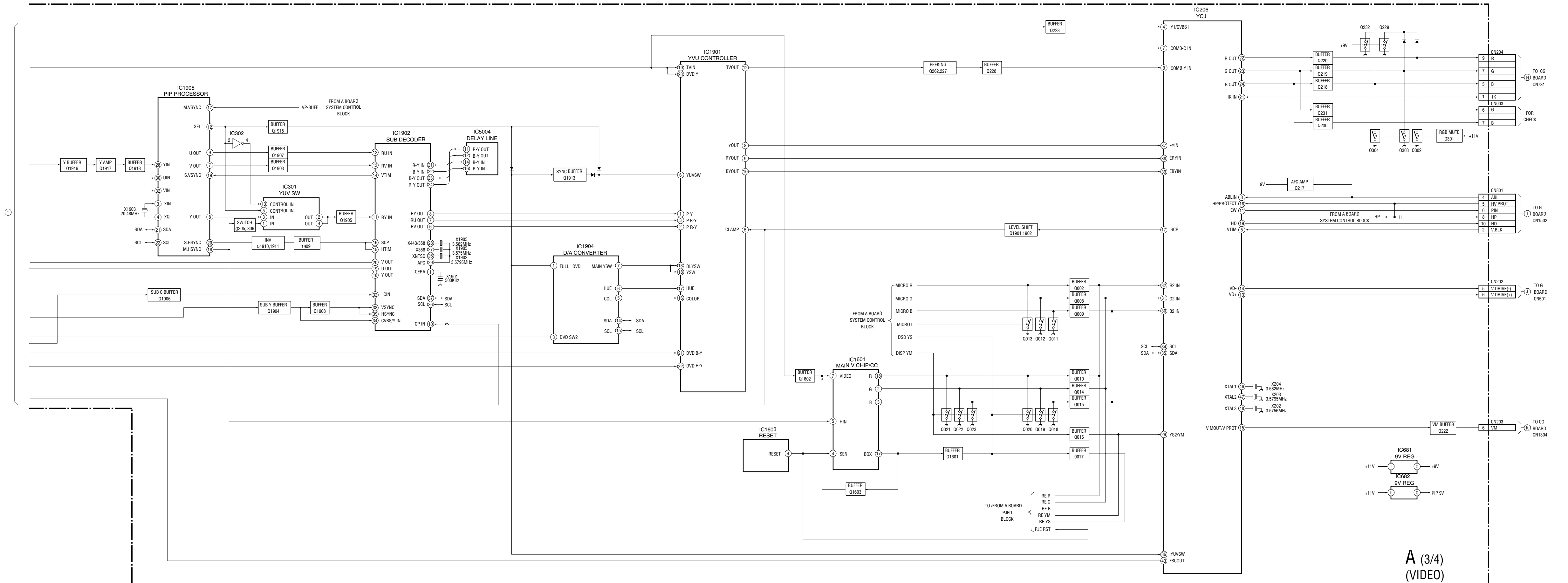

Fig. 5-7

BLOCK DIAGRAM (2)



A (2/4)
(TUNER, VIDEO, AUDIO IN/OUT)



BLOCK DIAGRAM (3)

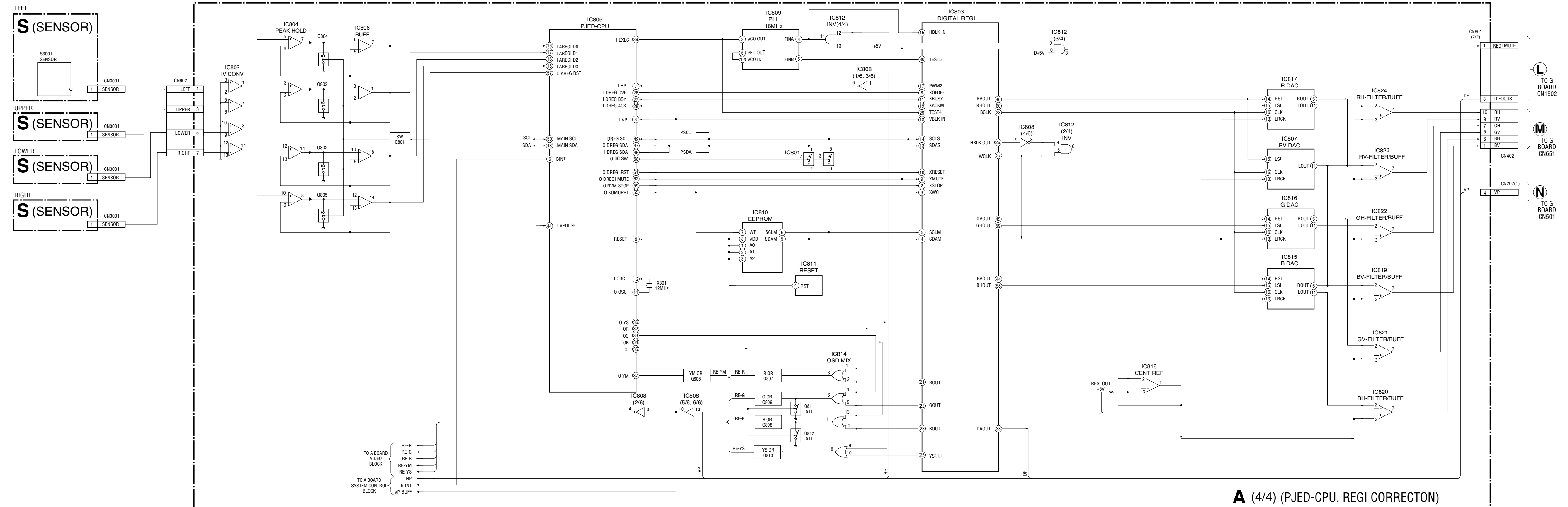

A (4/4) (PJED-CPU, REGI CORRECTON)

BLOCK DIAGRAM (4)

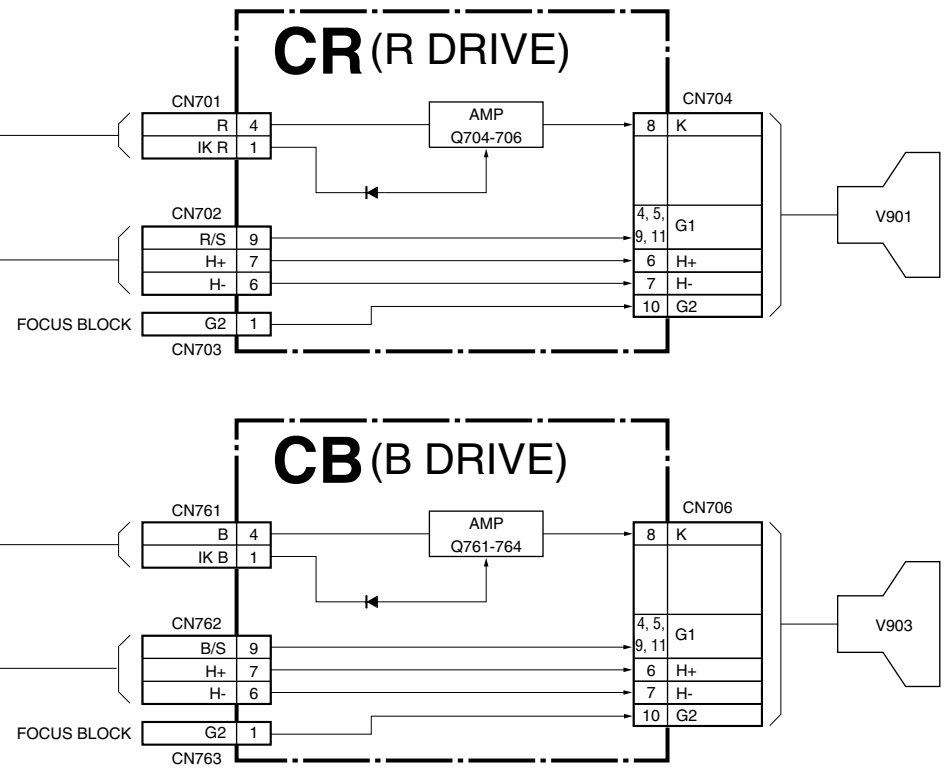
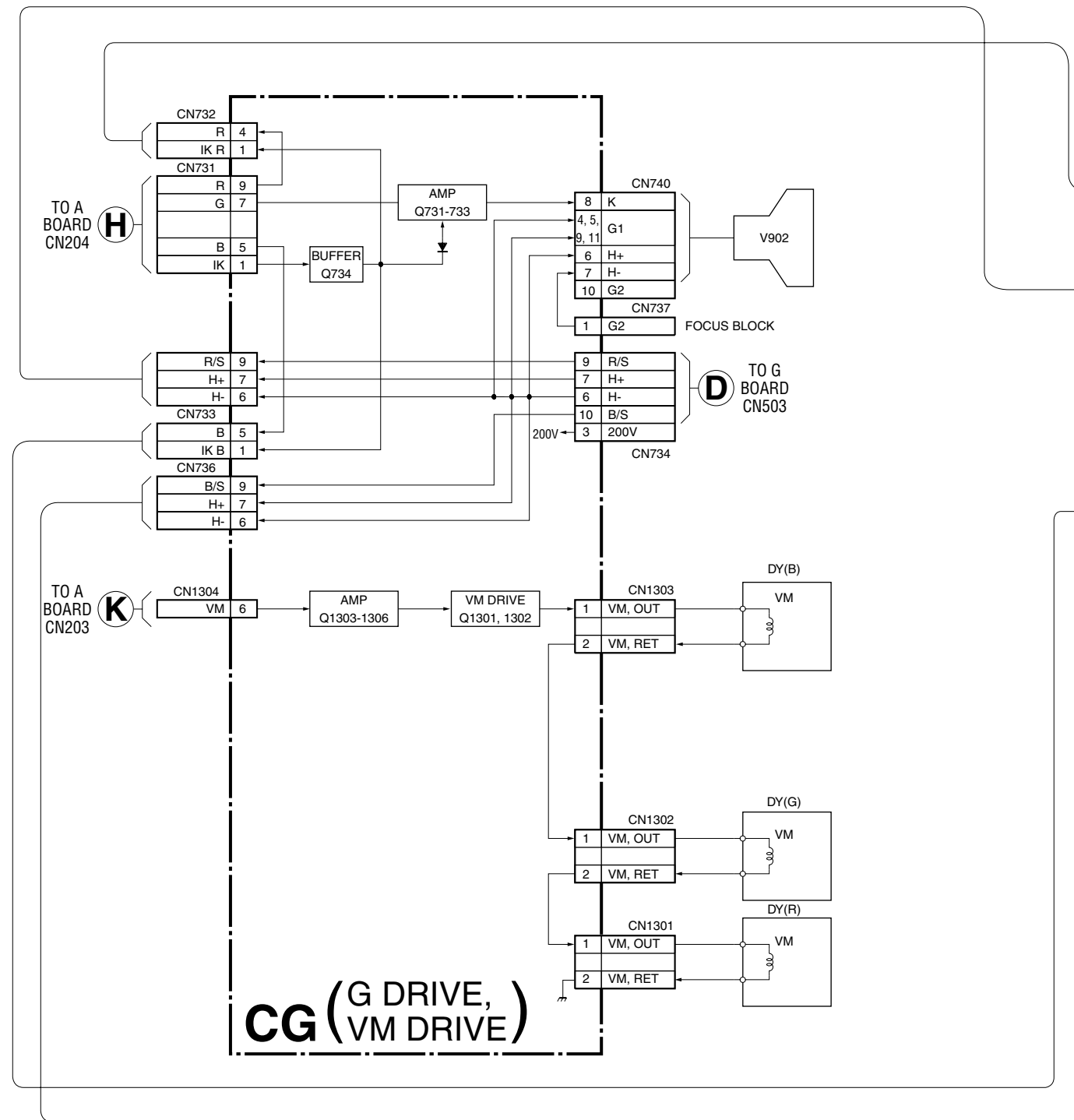

BLOCK DIAGRAM (5)

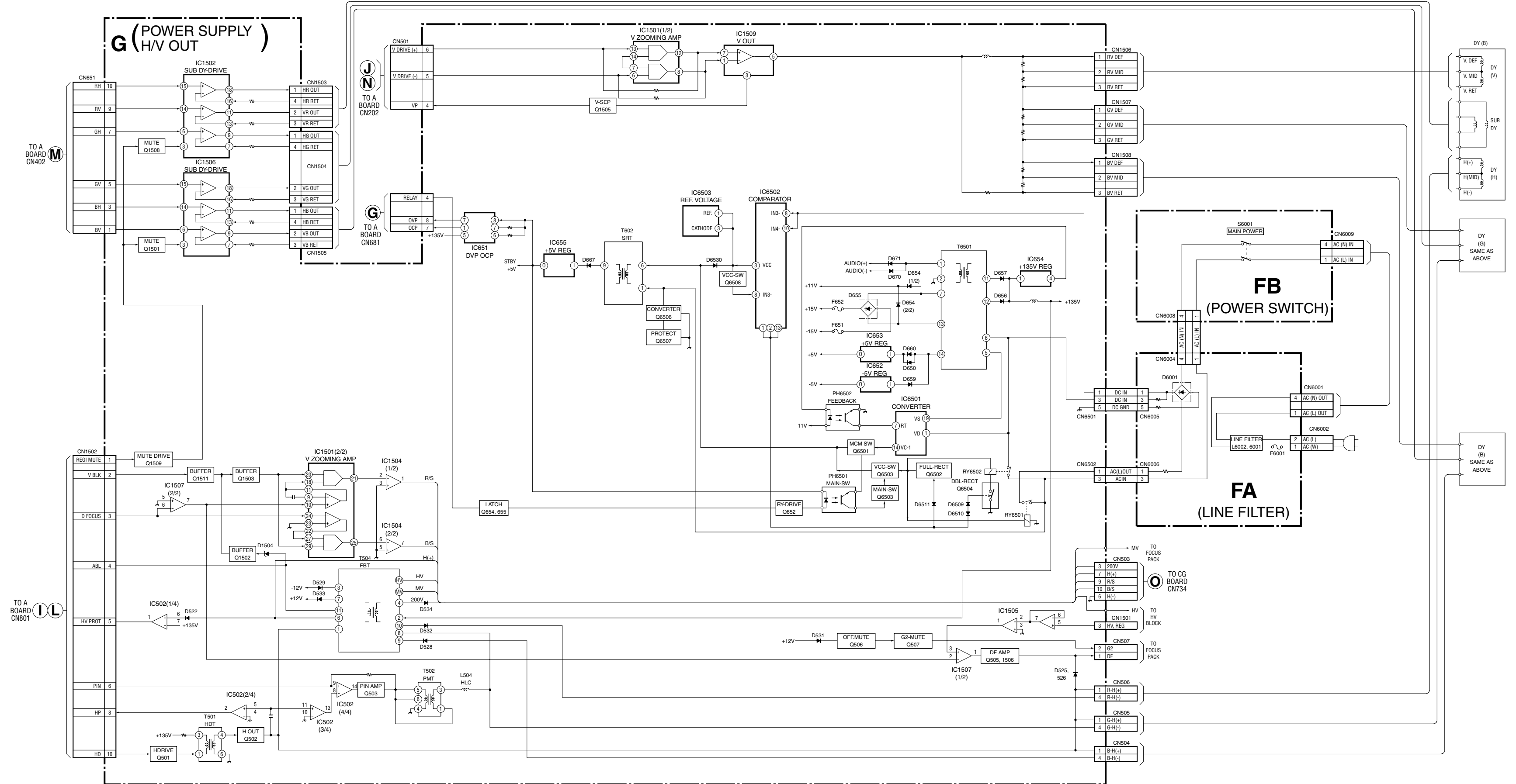

6-2. FRAME SCHEMATIC DIAGRAM

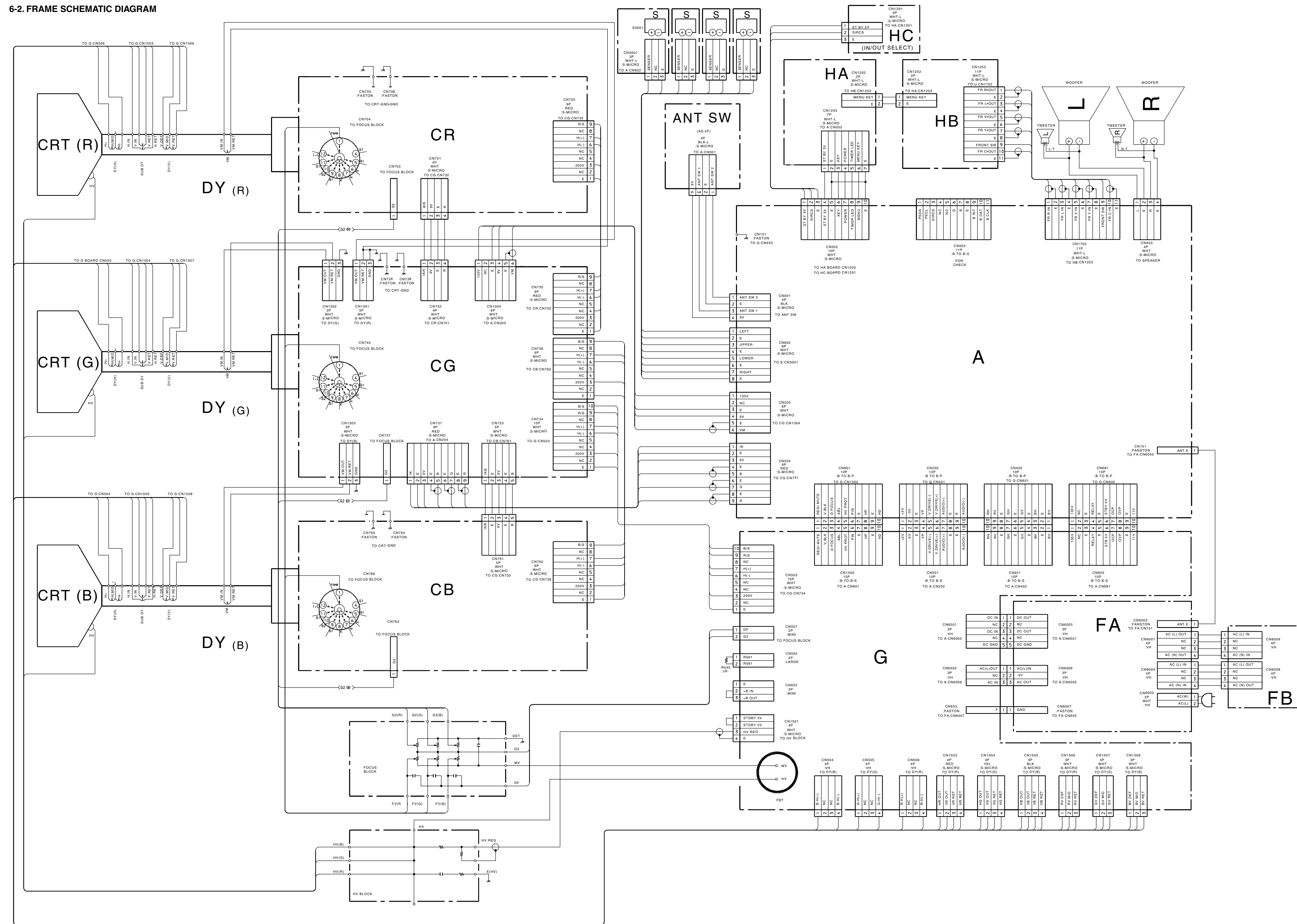

6-3. CIRCUIT BOARDS LOCATION

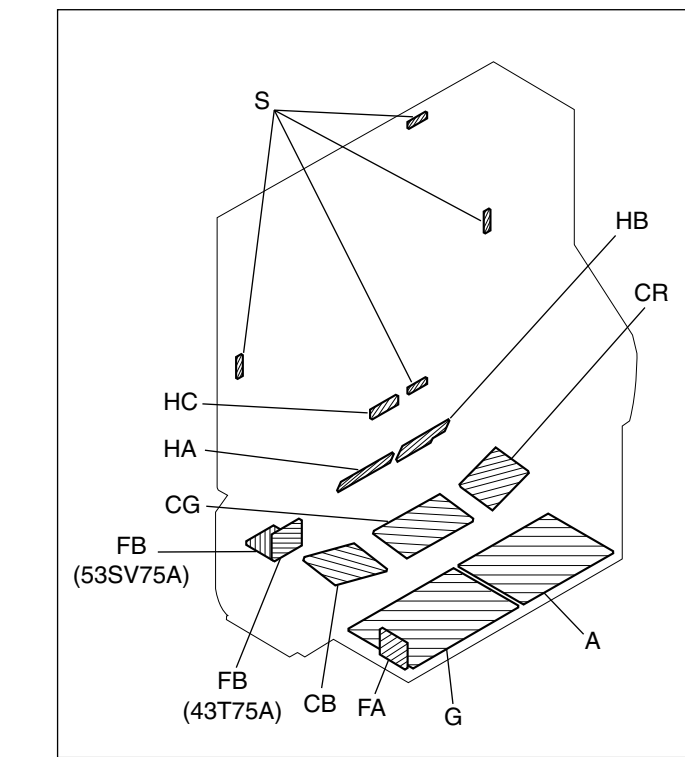

Note: The symbol display is on the component slide.
The components identified by shading and mark are critical for safety. Replace only with part number specified.
The symbol indicate fast operating fuse. Replace only with fuse of same rating as marked.

Note: Les composants identifiés par un tramé et une marque sont critiques pour la sécurité. Ne les remplacer que par une pièce portant le numéro spécifié.
Le symbole indique une fusible à action rapide. Doit être remplacé par une fusible de même valeur, comme maque.

6-4. PRINTED WIRING BOARDS AND SCHEMATIC DIAGRAMS

Note:
 • Capacitors without voltage indication are all 50V.
 • All resistors are in ohms.
 kΩ=1000Ω, MΩ=1000kΩ
 • Indication of resistance, which does not have one for rating electrical power, is as follows:
 □ Filch : 50m
 □ Rating electrical power : 1/4 W
 □ : nonflammable resistor.
 □ : fusible resistor.
 □ : internal component.
 □ : panel designation and adjustment for repair.
 • All variable and adjustable resistors have characteristic curve B, unless otherwise noted.
 • earth-chassis.
 • The components identified by in this basic schematic diagram have been carefully factory-selected for each set in order to satisfy regulations regarding X-ray radiation.
 Should replacement be required, replace only with the value originally used.
 • When replacing components identified by , make the necessary adjustments indicated. If results do not meet the specified value, change the component identified by and repeat the adjustment until the specified value is achieved. (Refer to R536, R545 and C517 adjustment on Page 38 - 39.)
 • When replacing the part in below table, be sure to perform the related adjustment.

Part replaced ()	Adjustment ()
C517, C521, C522, IC654, L504, T502, T504, DY, A board, G board	HV Regulator (C517)
C516, C536, D506, D507, D522, IC206, IC502, IC654, L504, R511, R522, R536, R538, R545, R548, R584, T502, T504, DY, A board, G board	HV HOLD-DOWN (R536, R545)

- Readings are taken with a NTS-C color-bar signal input.
- Readings are taken with a 10MΩ digital multimeter.
- Voltages are dc with respect to ground unless otherwise noted.
- Voltage variations may be noted due to normal production tolerances.
- All voltages are in V.
- Measurement impossibility.
- Circled numbers are waveform references.
- : B+ bus.
- : B- bus.
- : signal path.(RF)

Reference information
 RESISTOR : RN METAL FILM
 : RC SOLID
 : FPFD NONFLAMMABLE CARBON
 : FUSE NONFLAMMABLE FUSIBLE
 : RW NONFLAMMABLE WIREWOUND
 : RS NONFLAMMABLE METAL OXIDE
 : RB NONFLAMMABLE CEMENT
 : AJ ADJUSTMENT RESISTOR
 : LF-BL MICRO INDUCTOR
 CAPACITOR : TA TANTALUM
 : PS STYROL
 : PP POLYPROPYLENE
 : PT MYLAR
 : MPS METALIZED POLYESTER
 : MPP METALIZED POLYPROPYLENE
 : ALB BIPOLAR
 : ALT HIGH TEMPERATURE
 : ALR HIGH RIPPLE

Terminal name of semiconductors in silk screen printed circuit (*)

Device	Printed symbol	Terminal name	Circuit
① Transistor		Collector Base Emitter	
② Transistor		Collector Base Emitter	
③ Diode		Cathode Anode	
④ Diode		Cathode Anode (NC)	
⑤ Diode		Cathode Anode (NC)	
⑥ Diode		Common Anode Cathode	
⑦ Diode		Common Anode Cathode	
⑧ Diode		Common Anode Anode	
⑨ Diode		Common Anode Cathode	
⑩ Diode		Common Cathode Cathode	
⑪ Diode		Common Cathode Cathode	
⑫ Diode		Anode Anode Cathode Anode	
⑬ Transistor (FET)		Drain Source Gate	
⑭ Transistor (FET)		Drain Source Gate	
⑮ Transistor (FET)		Source Drain Gate	
⑯ Transistor		Emitter Collector Base	
⑰ Transistor		C1B1E1 E1B1C1 E1E1C2	
⑱ Transistor		C1B1E2 E1B1C2 E1E1C1	
⑳ Transistor		C1B1E2 E1B1C2 E1E1C2	
㉑ Transistor		E2B1E1 C2E1B2 C2E1B1	
㉒ Transistor		E2B1E2 C2E1B2 C2E1B1	
㉓ Transistor		E2E1E1 C2E1B2 C2E1B1	
㉔ Transistor		E2E1E2 C2E1B2 C2E1B1	
—		Discrete semiconductor	

(Chip semiconductors that are not actually used are included.) Ver 1.0

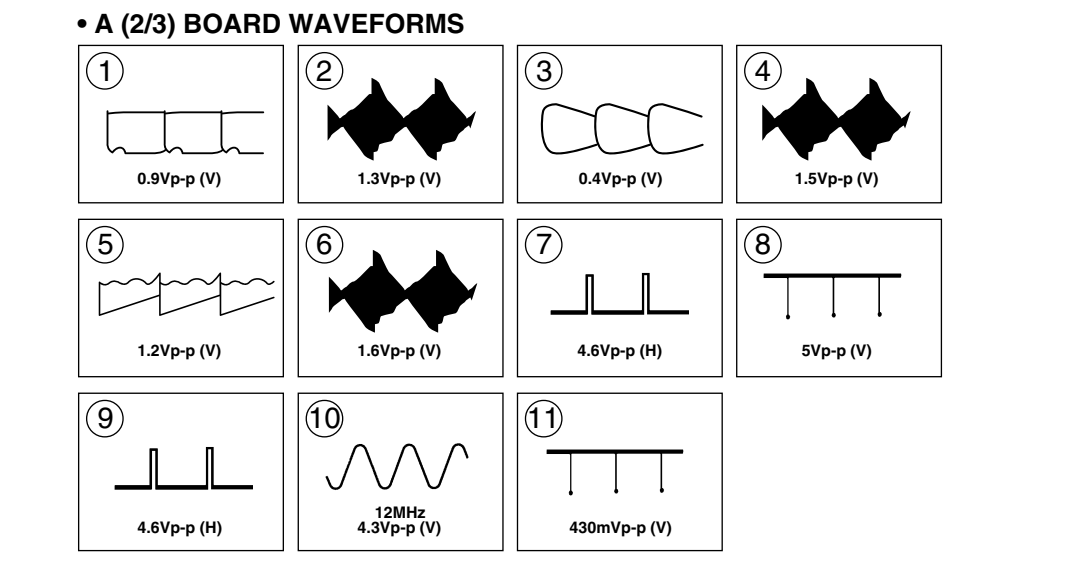
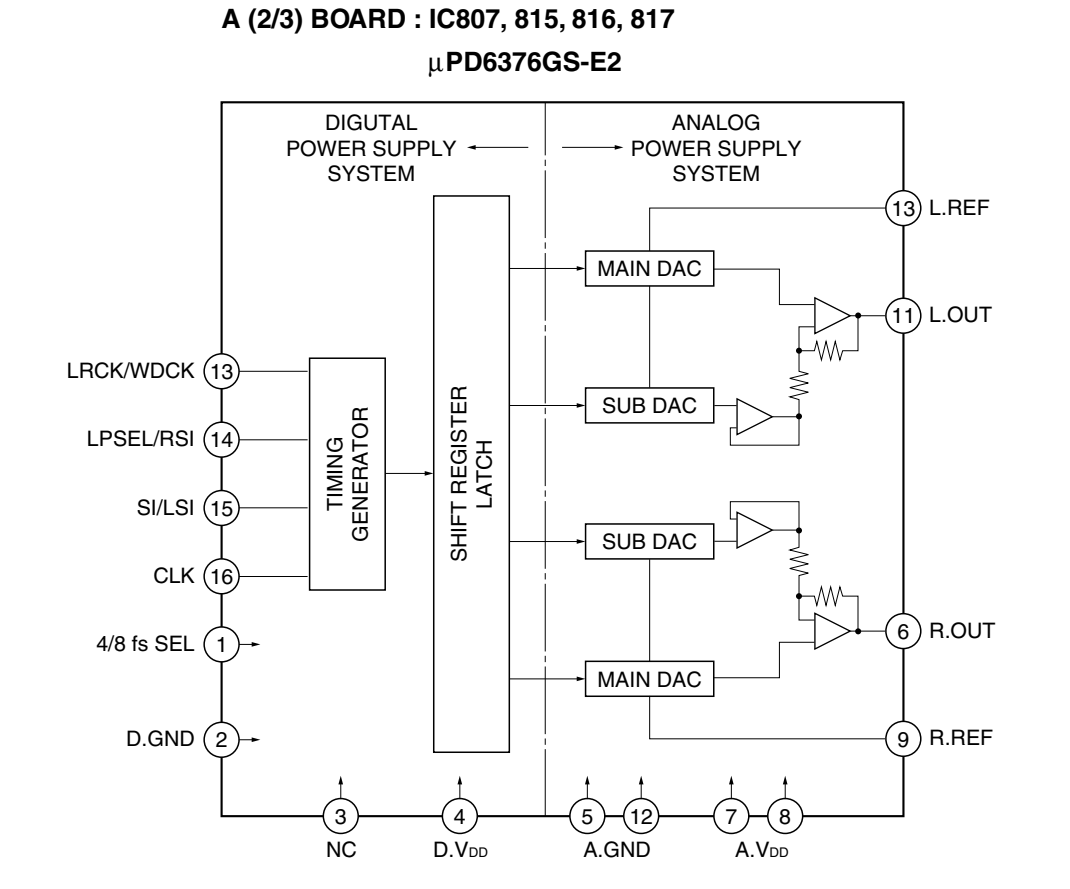
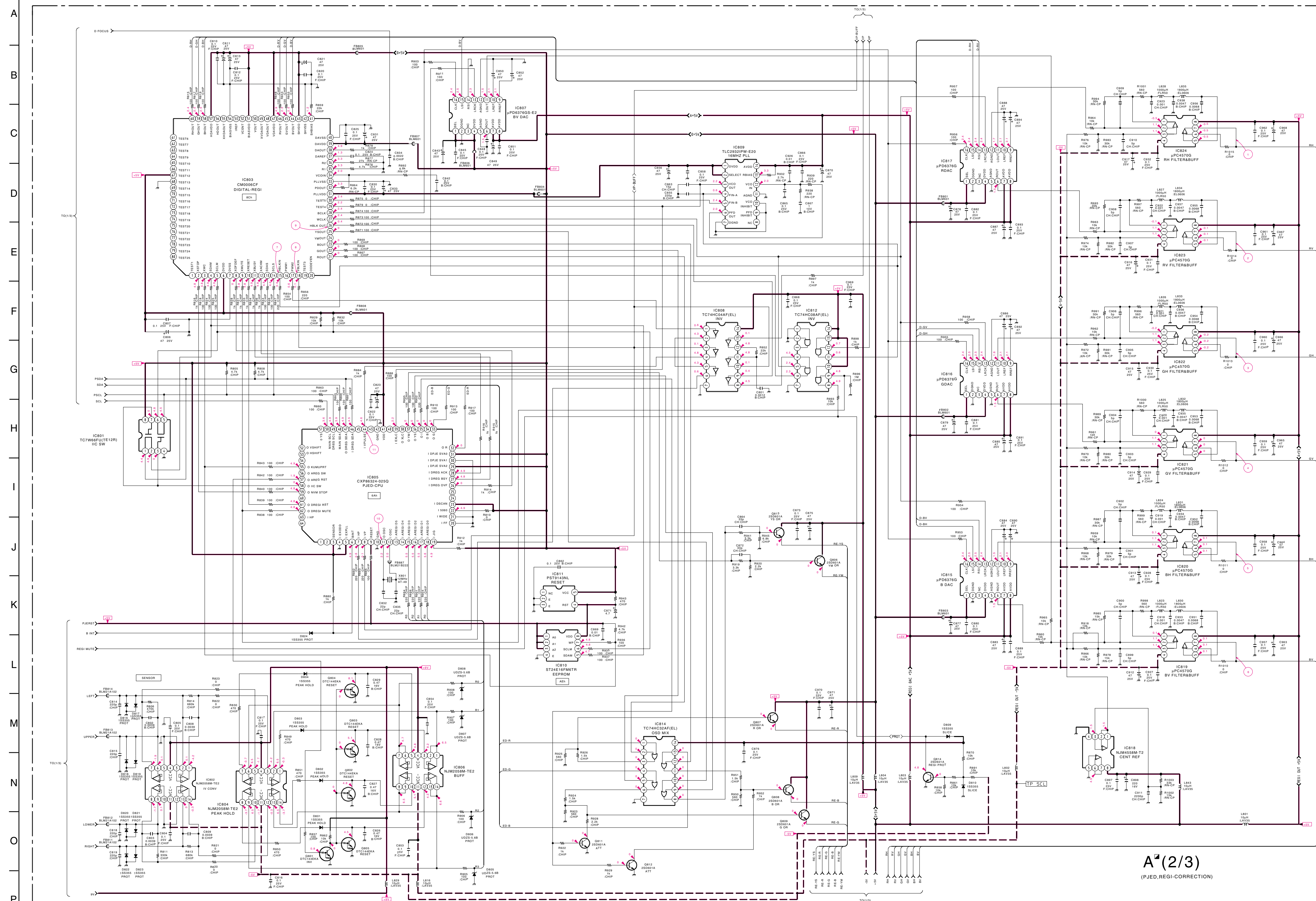

A²(2/3)
(PJED,REGI-CORRECTION)

S [PIN P, 3D COMB FILTER]

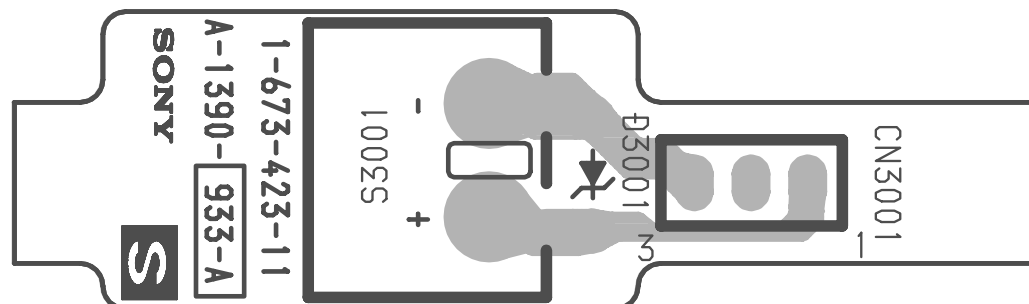

A (1/3) [TUNER, YCJ, SYSTEM CONTROL, AUDIO]

A (2/3) [PJED, REGI-CORRECTION]

A (3/3) [PIN P, 3D COMB FILTER]

- A Board -

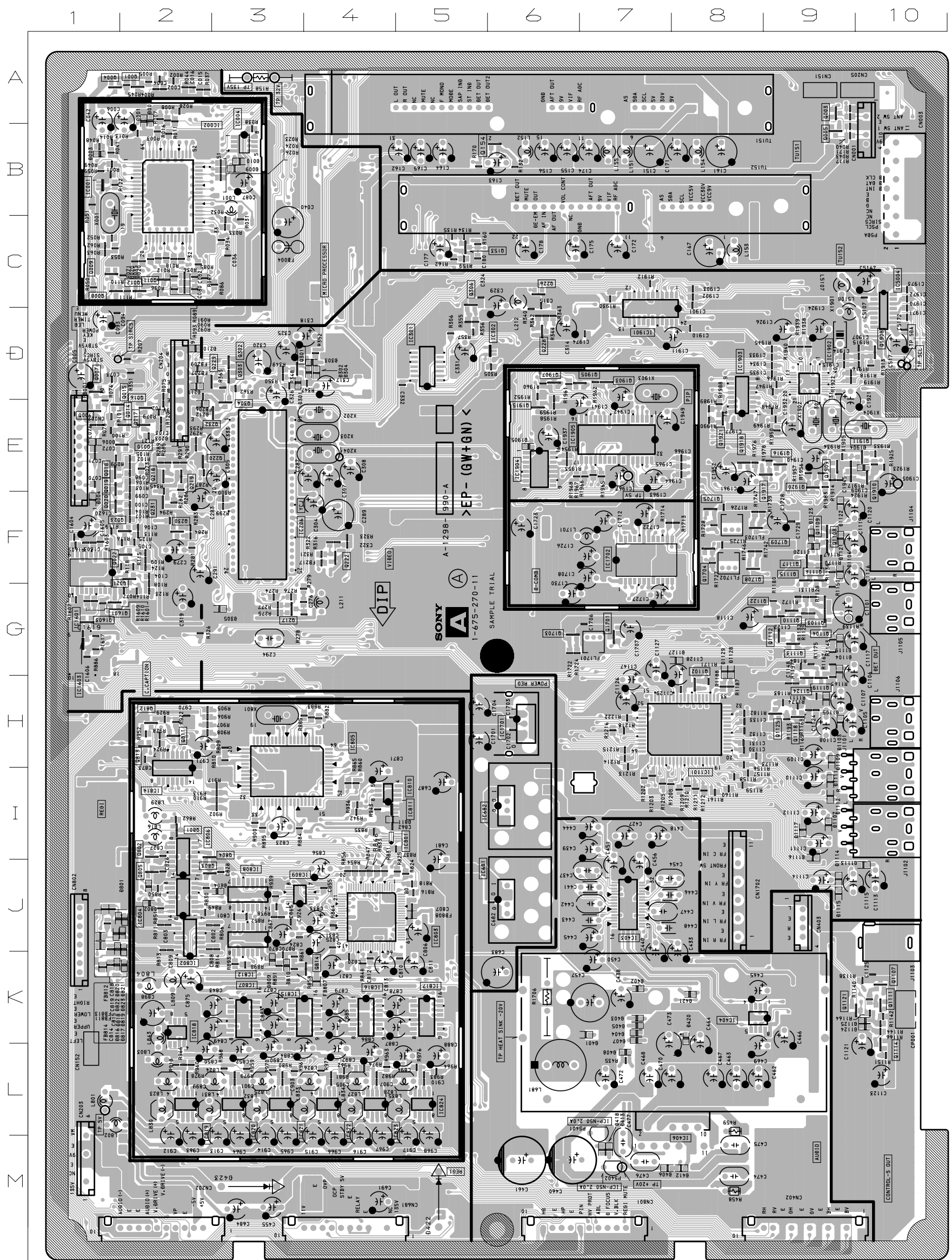

< Component Side >

A BOARD

DIODE		D307	C-4	D807	H-9	D1111	I-9	Q200	F-1	Q303	D-3	Q813	H-2	Q1124	H-9	Q1913	E-5	IC802	J-2
D001	A-2	D402	K-7	D808	H-9	D1112	I-9	Q021	F-2	Q304	E-3	Q814	K-4	Q1125	H-9	Q1914	E-3	IC803	J-4
D002	A-2	D403	K-7	D809	K-3	D1113	J-10	Q022	F-2	Q305	E-3	Q1101	G-1	Q1102	H-8	Q1915	E-5	IC804	J-2
D003	B-1	D404	K-7	D810	K-3	D1114	J-9	Q023	F-2	Q306	C-5	Q1102	H-8	Q1602	F-10	Q1916	E-9	IC805	I-3
D004	F-1	D405	K-7	D811	K-1	D1115	J-9	Q041	K-4	Q401	K-4	Q1103	G-9	Q1603	G-1	Q1917	E-9	IC806	I-2
D005	B-10	D406	M-7	D812	J-2	D1116	I-9	Q402	K-4	Q402	K-4	Q1104	G-9	Q1701	G-7	Q1918	E-9	IC807	K-3
D006	E-1	D407	K-7	D813	K-1	D1117	I-9	Q403	L-4	Q403	L-4	Q1105	G-2	Q1702	G-5	Q1919	E-8	IC808	J-3
D007	B-10	D408	L-7	D814	J-2	D1118	J-2	Q404	L-4	Q404	L-4	Q1106	K-2	Q1703	G-6	Q1920	E-8	IC809	J-3
D008	B-3	D409	L-4	D815	J-1	D1119	G-9	Q405	K-3	Q405	K-3	Q1107	K-10	Q1704	F-8	Q1921	E-8	IC810	I-4
D009	B-3	D410	L-4	D816	J-1	D1120	F-9	Q406	K-3	Q406	K-3	Q1108	F-8	Q1705	F-8	Q1922	E-8	IC811	I-4
D010	B-3	D411	M-7	D817	J-2	D1121	F-9	Q407	E-2	Q407	E-2	Q1109	F-9	Q1706	F-8	Q1923	E-8	IC812	J-3
D151	A-3	D412	M-7	D818	J-1	D1122	F-9	Q411	K-4	Q411	K-4	Q1110	G-9	Q1707	F-3	Q1924	E-8	IC814	I-2
D202	G-8	D413	M-7	D819	J-2	D1123	F-9	Q801	H-2	Q801	H-2	Q1111	K-10	Q1708	F-8	Q1925	E-8	IC815	K-4
D206	D-9	D414	L-4	D820	J-1	D1124	K-10	Q802	H-2	Q802	H-2	Q1112	G-9	Q1709	F-8	Q1926	L-8	IC816	K-4
D207	D-9	D415	L-4	D821	J-2	D1125	K-10	Q803	J-2	Q803	J-2	Q1113	G-9	Q1903	D-7	Q1927	E-8	IC817	K-5
D301	D-3	D420	K-8	D822	J-1	D1126	G-1	Q804	I-2	Q804	I-2	Q1114	K-10	Q1904	D-2	Q1928	F-5	IC818	K-2
D302	D-4	D421	K-8	D823	J-2	D1127	G-8	Q805	J-2	Q805	J-2	Q1115	F-9	Q1905	D-7	Q1929	D-6	IC819	L-2
D303	D-4	D422	J-2	D824	H-8	D1128	F-9	Q806	L-9	Q806	L-9	Q1116	F-9	Q1906	D-6	Q1930	L-8	IC820	L-3
D304	D-4	D423	J-2	D825	H-2	D1129	G-9	Q807	H-9	Q807	H-9	Q1117	F-9	Q1907	D-6	Q1931	D-6	IC821	L-3
D305	G-3	D424	K-8	D826	H-9	D1130	H-9	Q808	H-9	Q808	H-9	Q1118	H-9	Q1908	D-10	Q1932	D-10	IC822	L-4
D306	F-9	D425	K-8	D827	H-9	D1131	H-9	Q809	H-9	Q809	H-9	Q1119	H-9	Q1909	E-9	Q1933	J-5	IC823	L-4
		D426	K-8	D828	H-9	D1132	H-9	Q810	E-1	Q810	E-1	Q1120	K-10	Q1910	E-10	Q1934	L-6	IC824	L-5
		D427	K-8	D829	H-9	D1133	I-2	Q811	H-2	Q811	H-2	Q1121	K-10	Q1911	E-10	Q1935	L-6	IC825	L-5
		D428	K-8	D830	H-9	D1134	I-2	Q812	H-2	Q812	H-2	Q1122	G-9	Q1912	E-10	Q1936	L-6	IC826	L-5
		D429	K-8	D831	H-9	D1135	I-2	Q813	H-2	Q813	H-2	Q1123	G-9	Q1913	E-10	Q1937	L-6	IC827	L-5
		D430	K-8	D832	H-9	D1136	I-2	Q814	H-2	Q814	H-2	Q1124	G-9	Q1914	E-10	Q1938	L-6	IC828	L-5
		D431	K-8	D833	H-9	D1137	I-2	Q815	H-2	Q815	H-2	Q1125	G-9	Q1915	E-10	Q1939	L-6	IC829	L-5
		D432	K-8	D834	H-9	D1138	I-2	Q816	H-2	Q816	H-2	Q1126	G-9	Q1916	E-10	Q1940	L-6	IC830	L-5
		D433	K-8	D835	H-9	D1139	I-2	Q817	H-2	Q817	H-2	Q1127	G-9	Q1917	E-10	Q1941	L-6	IC831	L-5
		D434	K-8	D836	H-9	D1140	I-2	Q818	H-2	Q818	H-2	Q1128	G-9	Q1918	E-10	Q1942	L-6	IC832	L-5
		D435	K-8	D837	H-9	D1141	I-2	Q819	H-2	Q819	H-2	Q1129	G-9	Q1919	E-10	Q1943	L-6	IC833	L-5
		D436	K-8	D838	H-9	D1142	I-2	Q820	H-2	Q820	H-2	Q1130	G-9	Q1920	E-10	Q1944	L-6	IC834	L-5
		D437	K-8	D839	H-9	D1143	I-2	Q821	H-2	Q821	H-2	Q1131	G-9	Q1921	E-10	Q1945	L-6	IC835	L-5
		D438	K-8	D840	H-9	D1144	I-2	Q822	H-2	Q822	H-2	Q1132	G-9	Q1922	E-10	Q1946	L-6	IC836	L-5
		D439	K-8	D841	H-9	D1145	I-2	Q823	H-2	Q823	H-2	Q1133	G-9	Q1923	E-10	Q1947	L-6	IC837	L-5
		D440	K-8	D842	H-9	D1146	I-2	Q824	H-2	Q824	H-2	Q1134	G-9	Q1924	E-10	Q1948	L-6	IC838	L-5
		D441	K-8	D843	H-9	D1147	I-2	Q825	H-2	Q825	H-2	Q1135	G-9	Q1925	E-10	Q1949	L-6	IC839	L-5
		D442	K-8	D844	H-9	D1148	I-2	Q826	H-2	Q826	H-2	Q1136	G-9	Q1926	E-10	Q1950	L-6	IC840	L-5
		D443	K-8	D845	H-9	D1149	I-2	Q827	H-2	Q827	H-2	Q1137	G-9	Q1927	E-10	Q1951	L-6	IC841	L-5
		D444	K-8	D846	H-9	D1150	I-2	Q828	H-2	Q828	H-2	Q1138	G-9	Q1928	E-10	Q1952	L-6	IC842	L-5
		D445	K-8	D847	H-9	D1151	I-2	Q829	H-2	Q829	H-2	Q1139	G-9	Q1929	E-10	Q1953	L-6	IC843	L-5
		D446	K-8	D848	H-9	D1152	I-2	Q830	H-2	Q830	H-2	Q1140	G-9	Q1930	E-10	Q1954	L-6	IC844	L-5
		D447	K-8	D849	H-9	D1153	I-2	Q831	H-2	Q831	H-2	Q1141	G-9	Q1931	E-10	Q1955	L-6	IC845	L-5
		D448	K-8	D850	H-9	D1154	I-2	Q832	H-2	Q832	H-2	Q1142	G-9	Q1932	E-10	Q1956	L-6	IC846	L-5
		D449	K-8	D851	H-9	D1155	I-2	Q833	H-2	Q833	H-2	Q1143	G-9	Q1933	E-10	Q1957	L-6	IC847	L-5
		D450	K-8	D852	H-9	D1156	I-2	Q834	H-2	Q834	H-2	Q1144	G-9	Q1934	E-10	Q1958	L-6	IC848	L-5
		D451	K-8	D853	H-9	D1157	I-2	Q835	H-2	Q835	H-2	Q1145	G-9	Q1935	E-10	Q1959	L-6	IC849	L-5
		D452	K-8	D854	H-9	D1158	I-2	Q836	H-2	Q836	H-2	Q1146	G-9	Q1936	E-10	Q1960	L-6	IC850	L-5
		D453	K-8	D855	H-9	D1159	I-2	Q837	H-2	Q837	H-2	Q1147	G-9	Q1937	E-10	Q1961	L-6	IC851	L-5
		D454	K-8	D856	H-9	D1160	I-2	Q838	H-2	Q838	H-2	Q1148	G-9	Q1938	E-10	Q1962	L-6	IC852	L-5
		D455	K-8	D857	H-9	D1161	I-2	Q839	H-2	Q839	H-2	Q1149	G-9	Q1939	E-10	Q1963	L-6	IC853	L-5
		D456	K-8	D858	H-9	D1162	I-2	Q840	H-2	Q840	H-2	Q1150	G-9	Q1940	E-10	Q1964	L-6	IC854	L-5
		D457	K-8	D859	H-9	D1163	I-2	Q841	H-2	Q841	H-2	Q1151	G-9	Q1941	E-10	Q1965	L-6	IC855	L-5
		D458	K-8	D860	H-9	D1164	I-2	Q842	H-2	Q842	H-2	Q1152	G-9	Q1942	E-10	Q1966	L-6	IC856	L-5
		D459	K-8	D861	H-9	D1165	I-2	Q843	H-2	Q843	H-2	Q1153	G-9	Q1943	E-10	Q1967	L-6	IC857	L-5
		D460	K-8	D862	H-9	D1166	I-2	Q844	H-2	Q844	H-2	Q1154	G-9	Q1944	E-10	Q1968	L-6	IC858	L-5
		D461	K-8	D863	H-9	D1167	I-2	Q845	H-2	Q845	H-2	Q1155	G-9	Q1945	E-10	Q1969	L-6	IC859	L-5
		D462	K-8	D864	H-9	D1168	I-2	Q846	H-2	Q846	H-2	Q1156	G-9	Q1946	E-10	Q1970	L-6	IC860	L-5
		D463	K-8	D865	H-9	D1169	I-2	Q847	H-2	Q847	H-2	Q1157	G-9	Q1947	E-10	Q1971	L-6	IC861	L-5
		D464	K-8	D866	H-9	D1170	I-2	Q848	H-2	Q848	H-2	Q1158	G-9	Q1948	E-10	Q1972	L-6	IC862	L-5
		D465	K-8	D867	H-9	D1171	I-2	Q849	H-2	Q849	H-2	Q1159	G-9	Q1949	E-10	Q1973	L-6	IC863	L-5
		D466	K-8	D868	H-9	D1172	I-2	Q850	H-2	Q850	H-2	Q1160	G-9	Q1950	E-10	Q1974	L-6	IC864	L-5
		D467	K-8	D869	H-9	D1173	I-2	Q851	H-2	Q851	H-2	Q1161	G-9	Q1951	E-10	Q1975	L-6	IC865	L-5
		D468	K-8	D870	H-9	D1174	I-2	Q852	H-2	Q852	H-2	Q1162	G-9	Q1952	E-10	Q1976	L-6	IC866	L-5
		D469	K-8	D871	H-9	D1175	I-2	Q853											

A
B
C
D
E
F
G
H
I
J
K
L
M
N
O
P

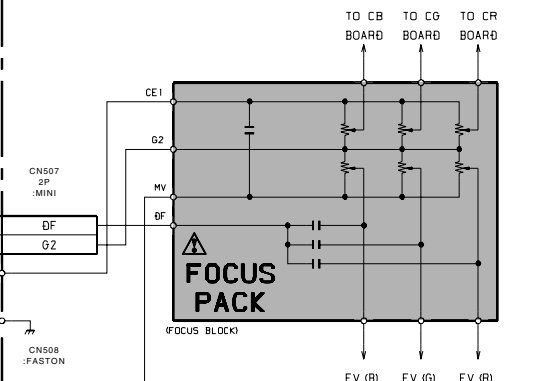
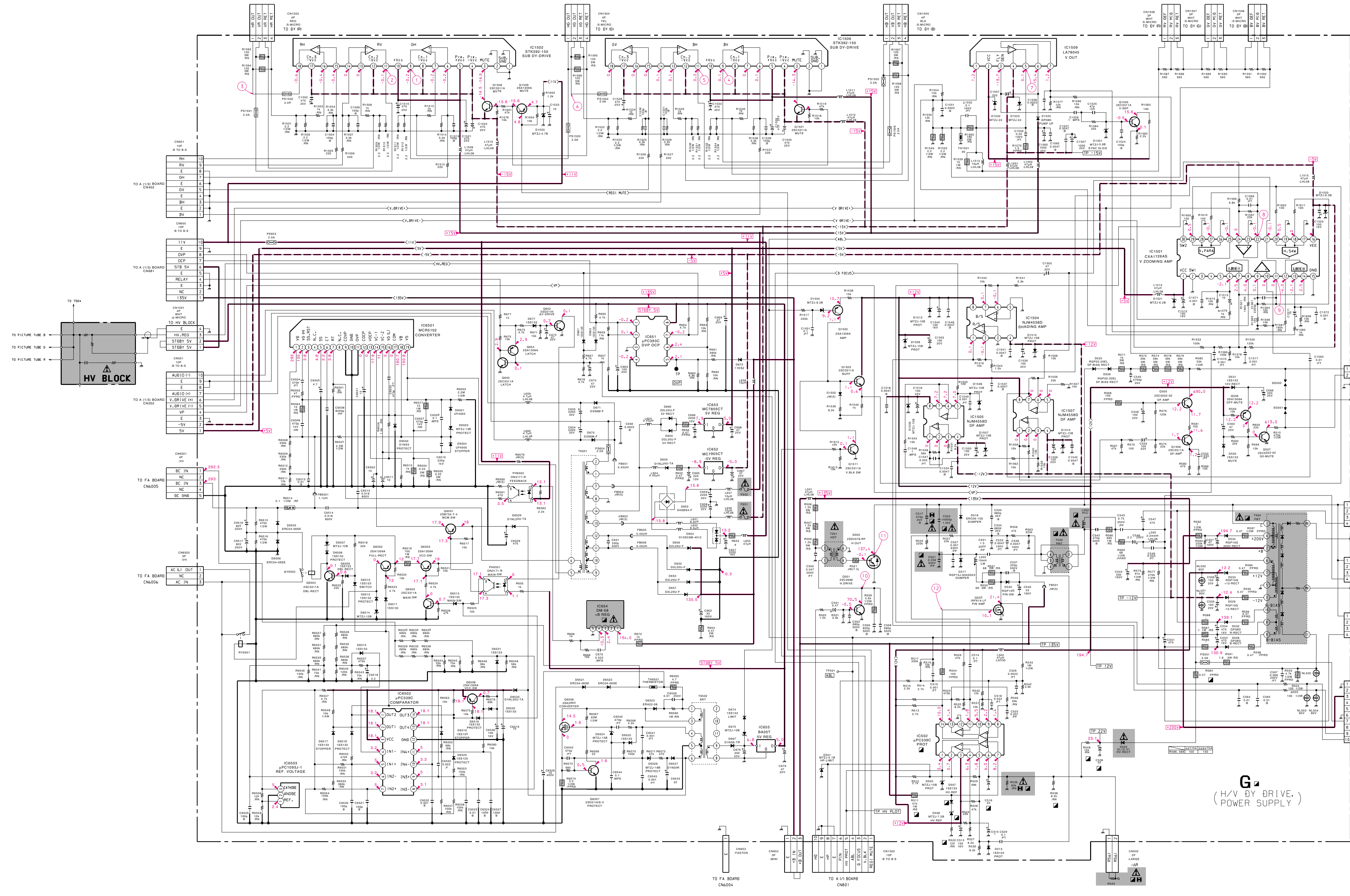
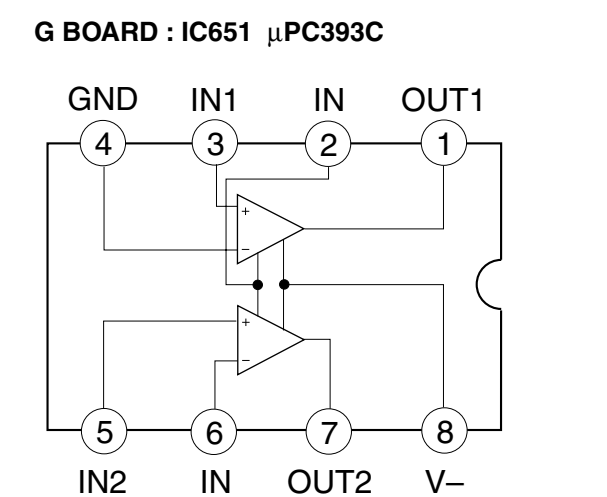
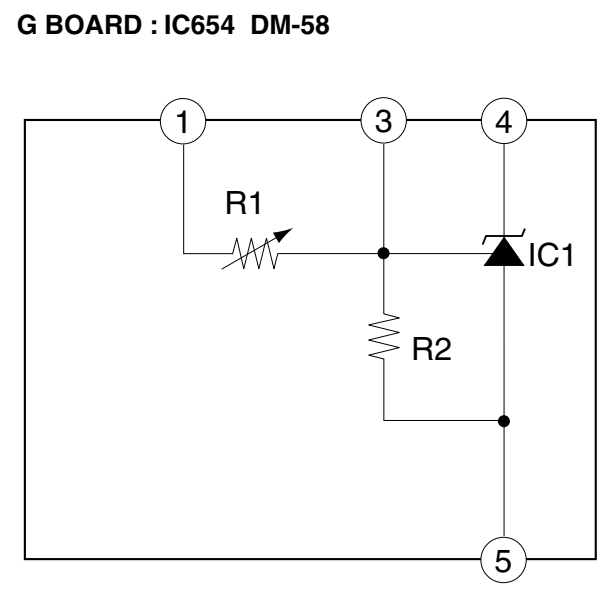
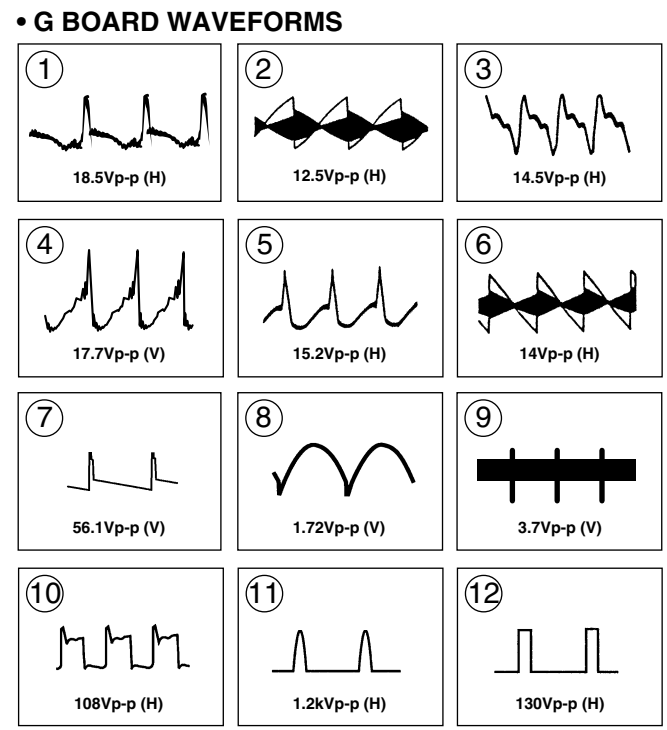

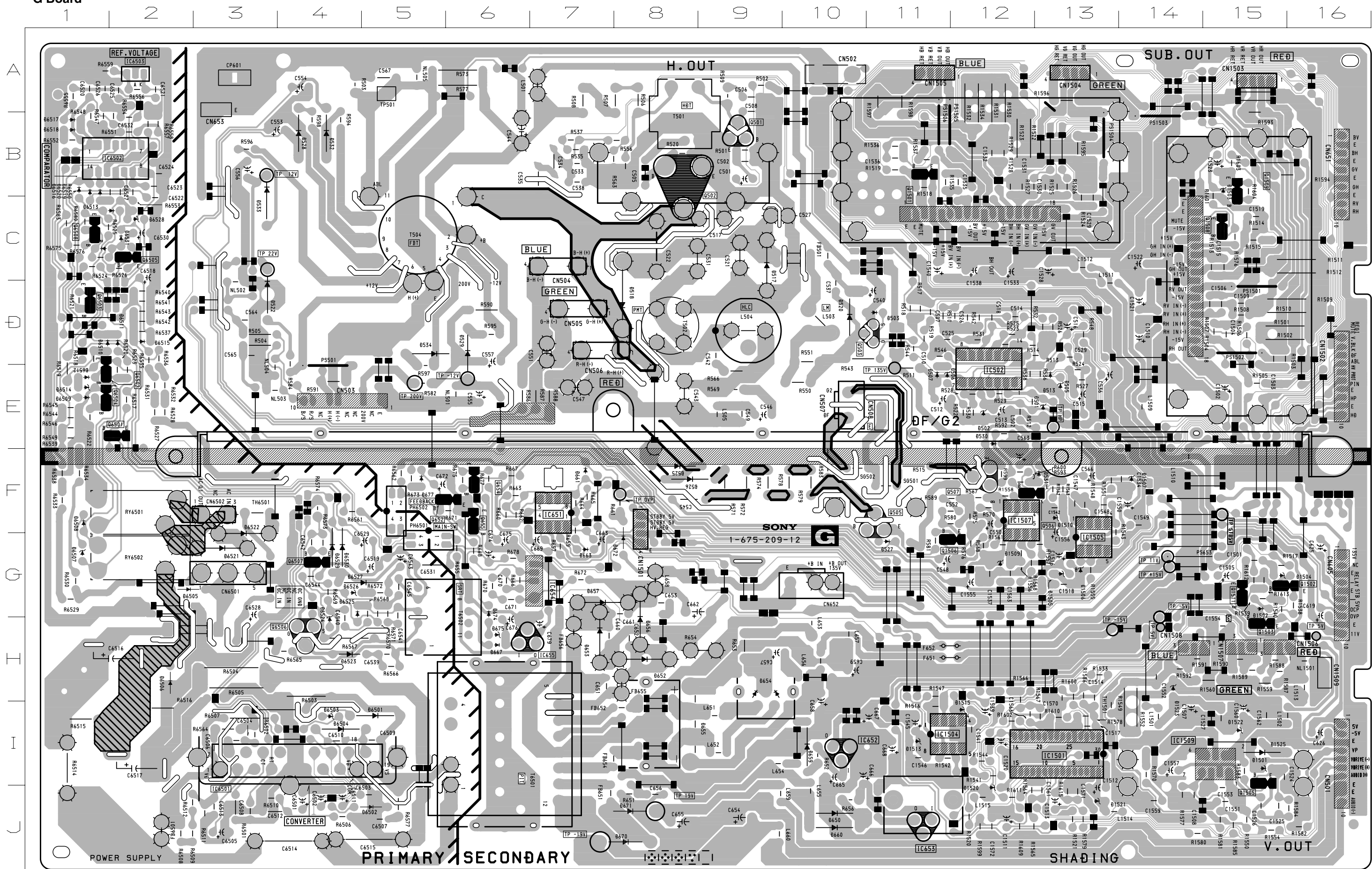

G BOARD

DIODE		TRANSISTOR		IC	
D501	E-13	Q501	B-9	IC502	E-12
D505	E-13	Q502	B-8	IC651	F-7
D506	E-11	Q503	D-11	IC652	I-10
D507	E-11	Q505	F-11	IC653	J-11
D513	E-13	Q506	F-12	IC654	G-7
D517	C-9	Q507	F-12	D6501	I-4
D518	D-8	Q652	F-5	D6502	J-5
D520	D-10	Q654	F-6	D6503	I-4
D522	D-3	Q655	F-6	D6504	I-4
D525	F-8	Q1501	B-11	D6505	G-2
D526	F-8	Q1502	G-16	D6506	H-2
D528	B-4	Q1503	H-15	D6507	G-1
D529	D-6	Q1505	J-15	D6508	F-1
D530	E-12	Q1506	G-12	D6509	E-1
D531	F-13	Q1508	C-15	D6510	D-2
D532	B-4	Q1509	B-15	D6511	D-2
D533	B-3	Q1511	G-15		
D534	D-5	Q6501	E-1		
D650	J-10	Q6502	E-1		
D652	H-8	Q6503	D-1		
D653	H-7	Q6504	E-1		
D654	H-9	Q6505	C-2		
D655	I-8	Q6506	H-4		
D656	H-8	Q6507	G-4		
D657	G-7	Q6508	C-1		
D659	I-10				
D660	J-10				
D661	F-7				
D663	G-7				
D667	H-6				
D670	J-7				
D671	J-8				
D672	G-8				
D674	G-6				
D675	H-6				
D677	F-5				
D1501	I-15				
D1502	H-15				
D1503	B-15				
D1504	G-15				
D1505	G-13				
D1506	G-13				
D1507	F-14				
D1509	G-12				
D1510	F-13				
D1513	I-11				
D1515	I-12				
D1520	J-12				
D1521	J-13				
D1522	I-15				
D1523	H-14				
D1525	I-15				

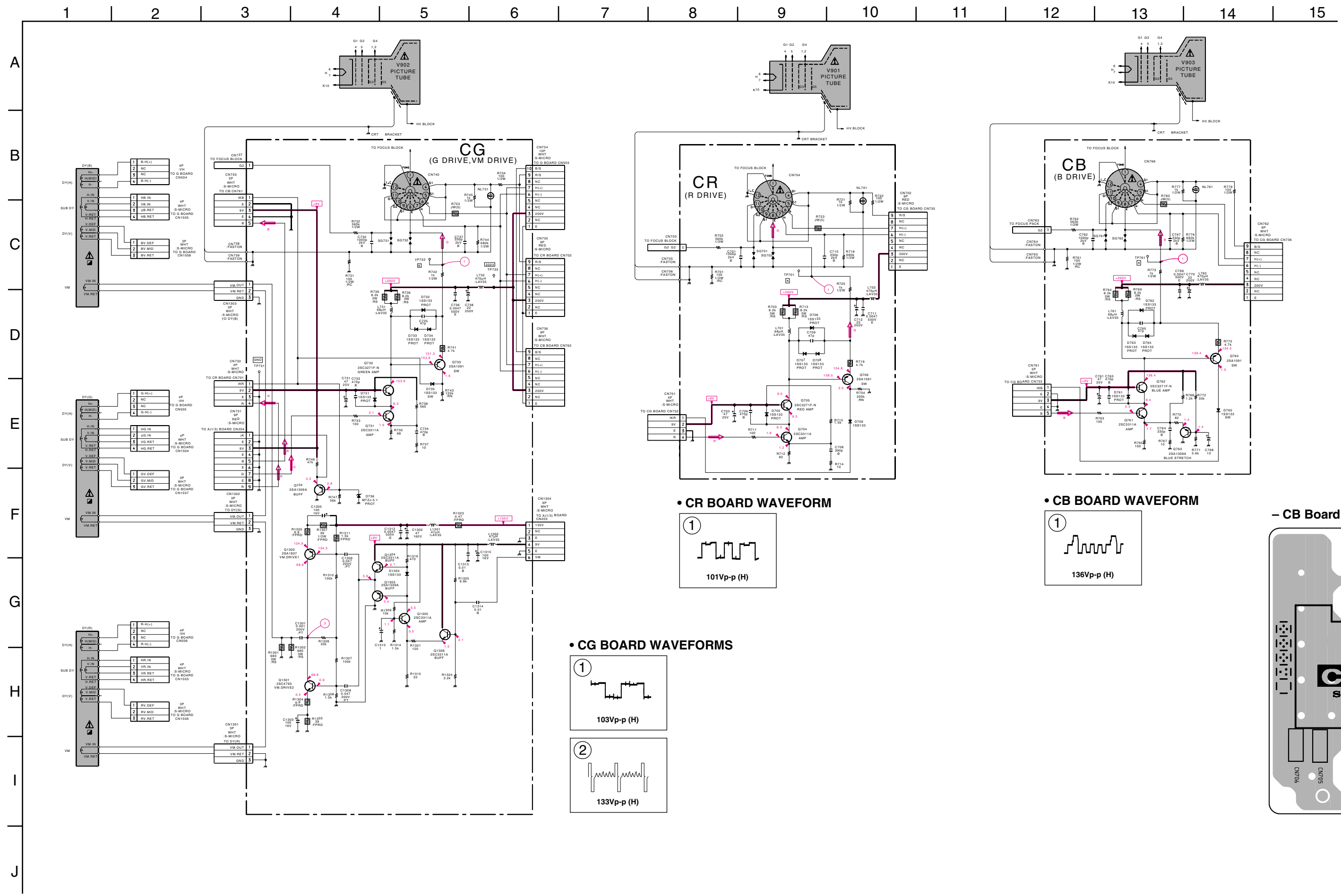

CG [G DRIVE, VM DRIVE] **CR** [R DRIVE] **CB** [B DRIVE]

- CG Board -

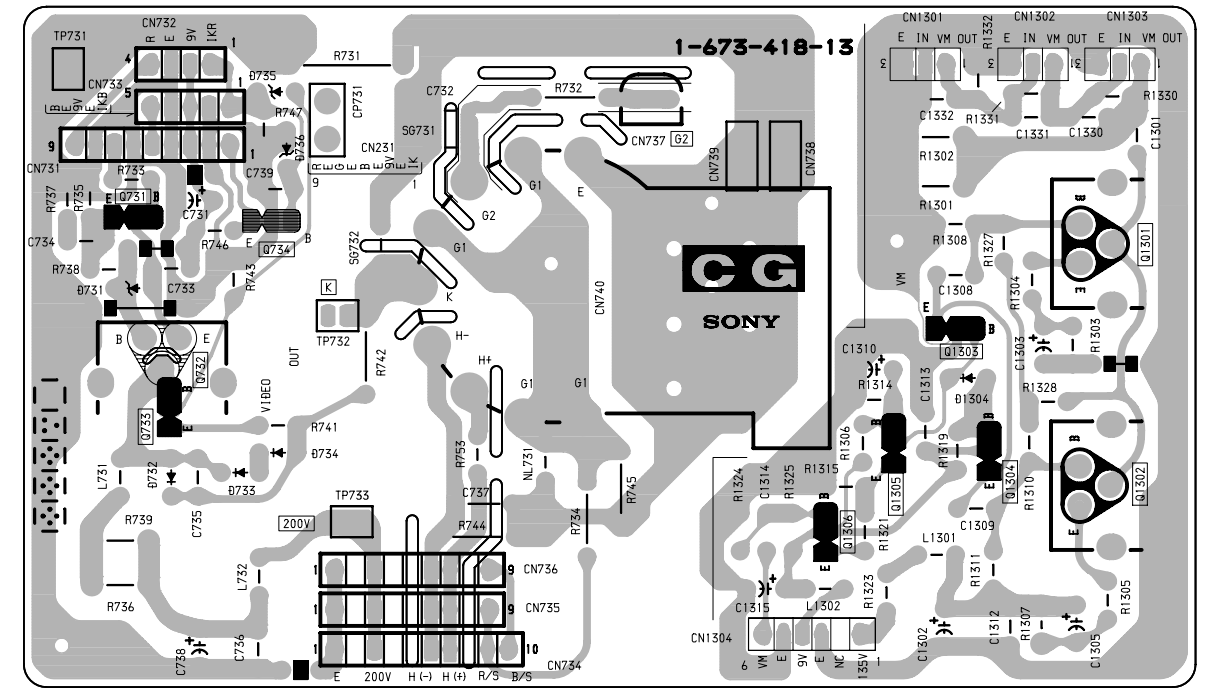

• CR BOARD WAVEFORM

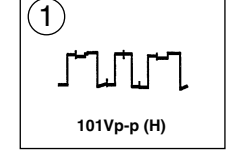

• CB BOARD WAVEFORM

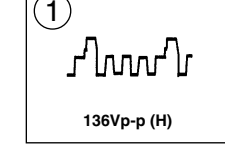

• CG BOARD WAVEFORMS

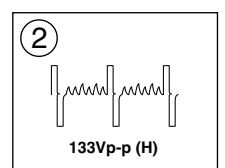
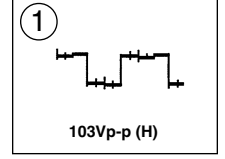

- CB Board -

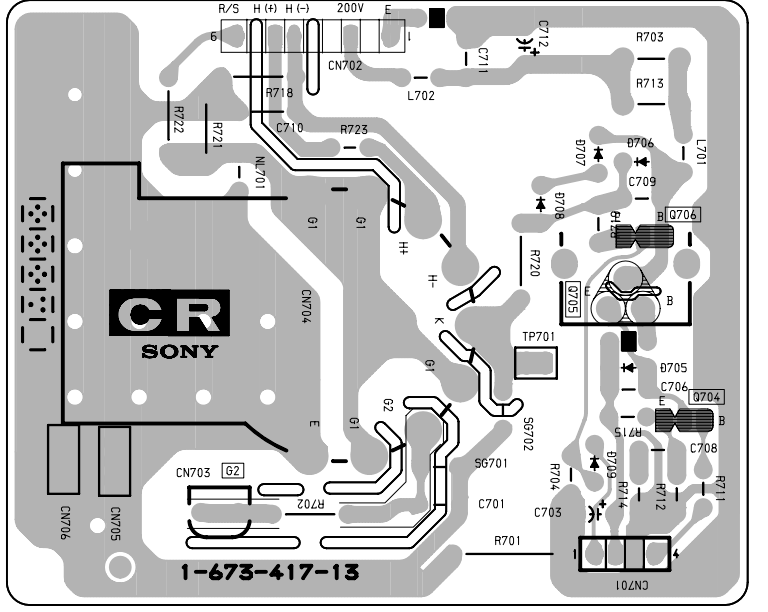

- CB Board -

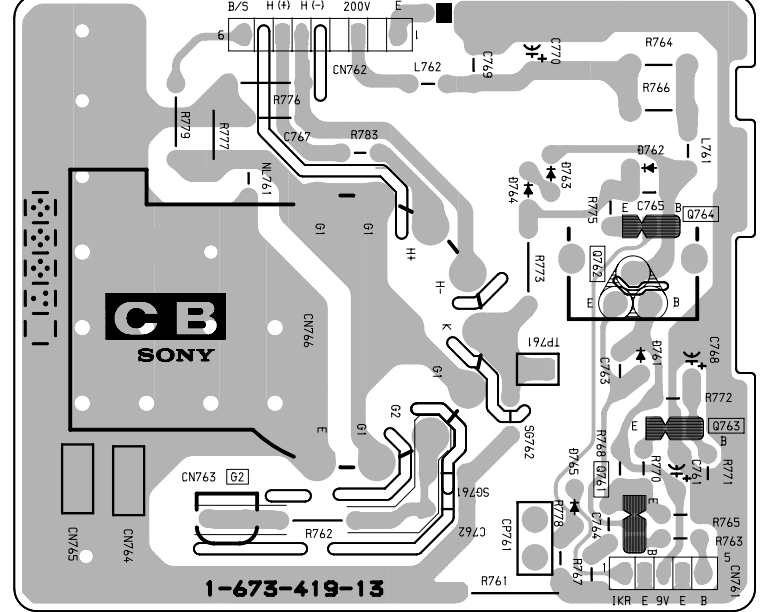

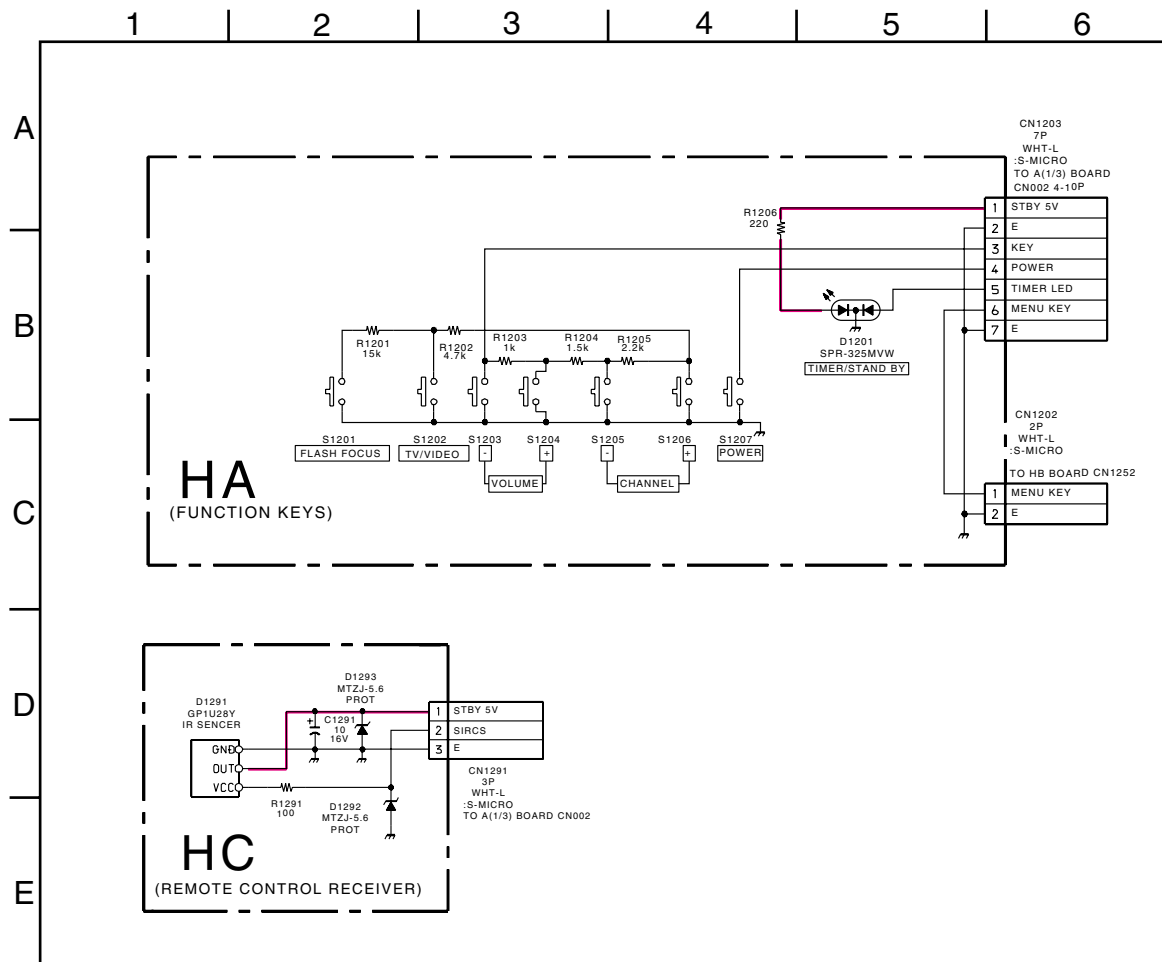

HA [FUNCTION KEK] **HC** [REMOTE CONTROL RECEIVER]

- HA Board -

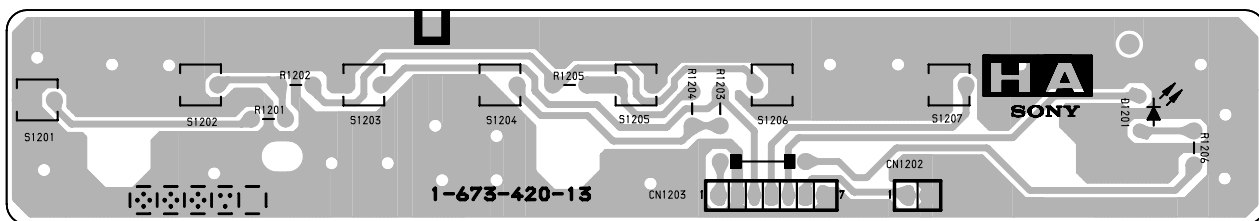

- HC Board -

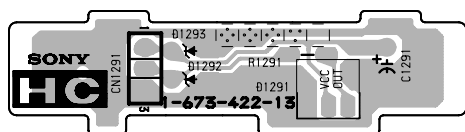

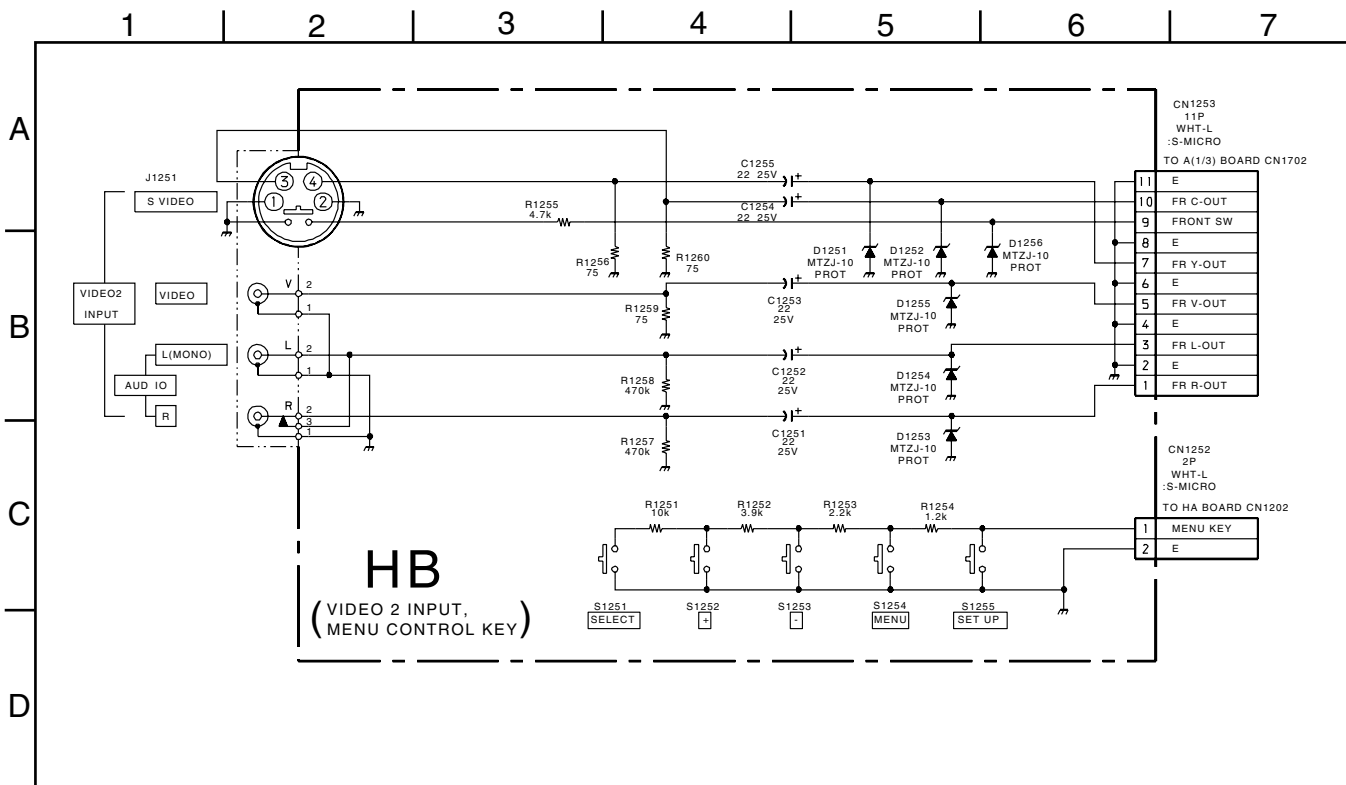

HB [VIDEO-2 INPUT, MENU CONTROL KEYS]

- HB Board -

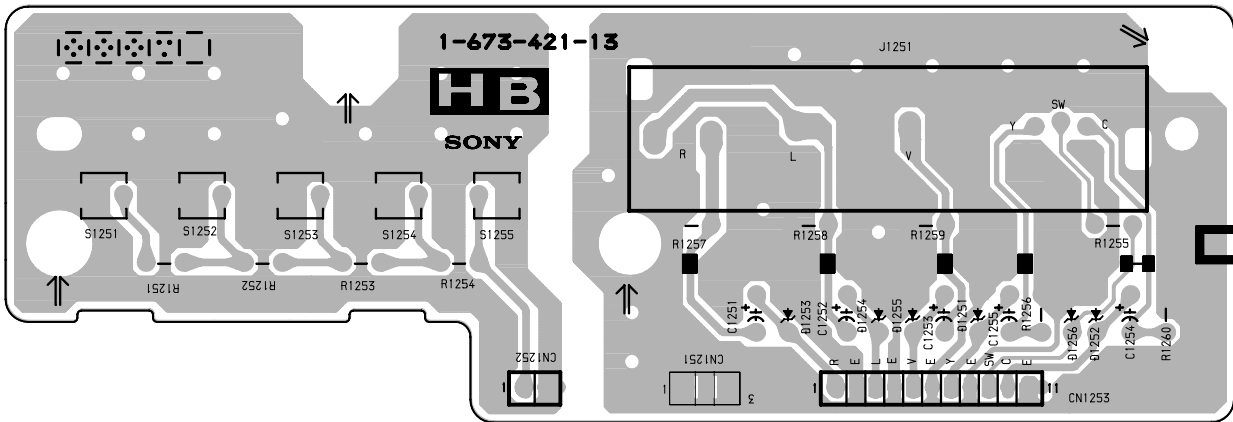

6-5. SEMICONDUCTORS

BA05T

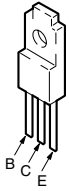

CXA2039M-T6

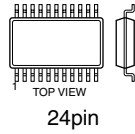

**MC7805CT
NJM7805FA**

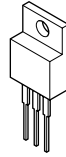

TC90A49F

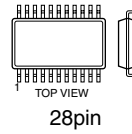

2SC2688-(5)LK

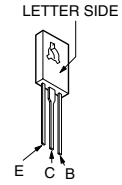

**BH3868FS-E2
SDA9288XE**

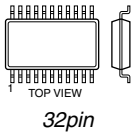

CXA2135S

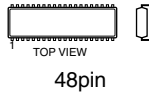

**MC7905CT
NJM7905FA**

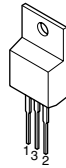

TDA7265

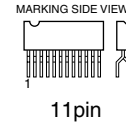

**2SA1162-G
2SD601A-Q
DTA144EKA-T146
DTC143TKA-T146
DTC144EKA-T146**

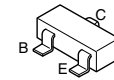

DM-58

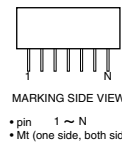

**BU4053BCF-T2
CXA1315M
TDA4662T
UPD6376GS-E2**

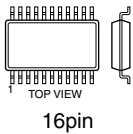

LA78045

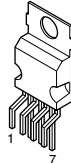

MCR5102

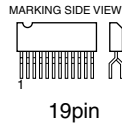

UPC1093J

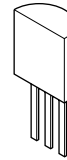

**2SA1175-HFE
2SA1309A
2SC3311A**

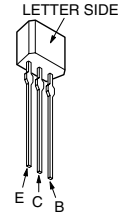

CM0006CF

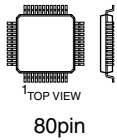

**M24C08-MN6T
NJM2533M(TE2)
NJM4558M-T2
ST24E16FM6TR
TC7W66FU(TE12R)
UPCM4570G2**

**NJM4558D
UPC393C
UPC4558G2**

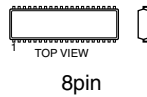

UPC339C

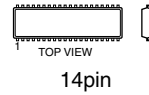

2SC5022-02

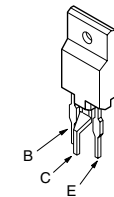

CXA1726AS

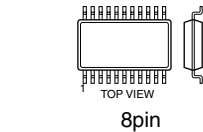
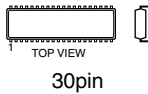

PQ09RD11

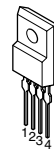

**Z8613012SSC-00TR
Z8622912SSC-00TR**

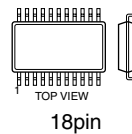

**CXA2079Q
CXP750010-016Q
CXP86324-025Q**

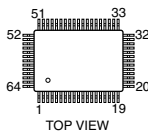

**MC74HC04AF
MC74HC32AF
NJM2058M-TE2
TC74HC04AF(EL)
TC74HC08AF(EL)
TC74HC32AF(EL)
TC74HC4066A
TLC2932IPW**

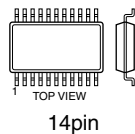

PST9143NL

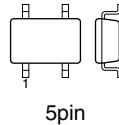

2SA1091-O

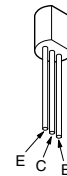

**2SD2144S-UVW
2SD2144S-V**

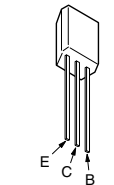

CXA2019AQ-T4

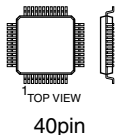

STK392-150

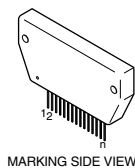

**2SA1837
2SC4793
IRF614**

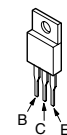

2SD2578-RF

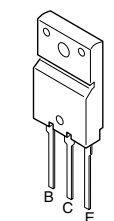

2SK2663

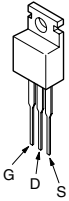

1SS355TE-17
 DTZ10B
 DTZ33B
 MA8039
 UDZ-TE17-10B
 UDZ-TE-17-22B
 UDZ-TE17-33B
 UDZS-TE17-10B
 UDZS-TE17-5.6B
 UDZS-TE17-8.2B

2SC3271F-N

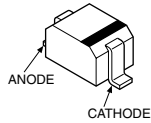
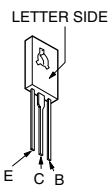

D1NL20U

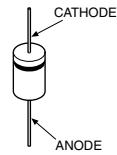

11ES2
 D1N20R
 D2L20U
 MTZJ-10B
 MTZJ-13
 MTZJ-15B
 MTZJ-2.7A
 MTZJ-3.9B
 MTZJ-4.7C
 MTZJ-5.1B
 MTZJ-7.5B
 MTZJ-T-77-4.7B
 MTZJ-T-77-10B
 MTZJ-T-77-12B
 MTZJ-T-77-13B
 MTZJ-T-77-15B
 MTZJ-T-77-18B
 MTZJ-T-77-24
 MTZJ-T-77-5.1B
 MTZJ-T-77-5.6B
 MTZJ-T-77-6.2B
 MTZJ-T-77-7.5B
 MTZJ-T-77-8.2B

D1NS6
 EL1Z
 GP08DPKG23
 RGP02-20EL-6394
 RGP10GPKG23
 RGP15J-6040G23

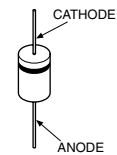

D4SB60L-F

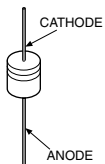
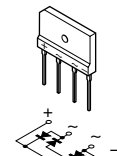

SLR-325VCT31

1SS133-T-77
 D3S6M-F
 ERA22-08
 ERC04-06SE
 ERC06-15S

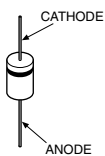
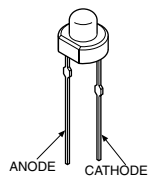

SECTION 7 EXPLODED VIEWS

NOTE:

- Items with no part number and no description are not stocked because they are seldom required for routine service
- The construction parts of an assembled part are indicated with a collation number in the remark column.

- Items marked " * " are not stocked since they are seldom required for routine service. Some delay should be anticipated when ordering these items.

The components identified by shading and mark ▲ are critical for safety. Replace only with part number specified.

7-1. COVER (KP-43T75A)

- : +BVTP 3X12 7-685-648-79
- ▲ : +BVTP 3X16 7-685-650-79
- : +BVTP 4X12 7-685-661-14

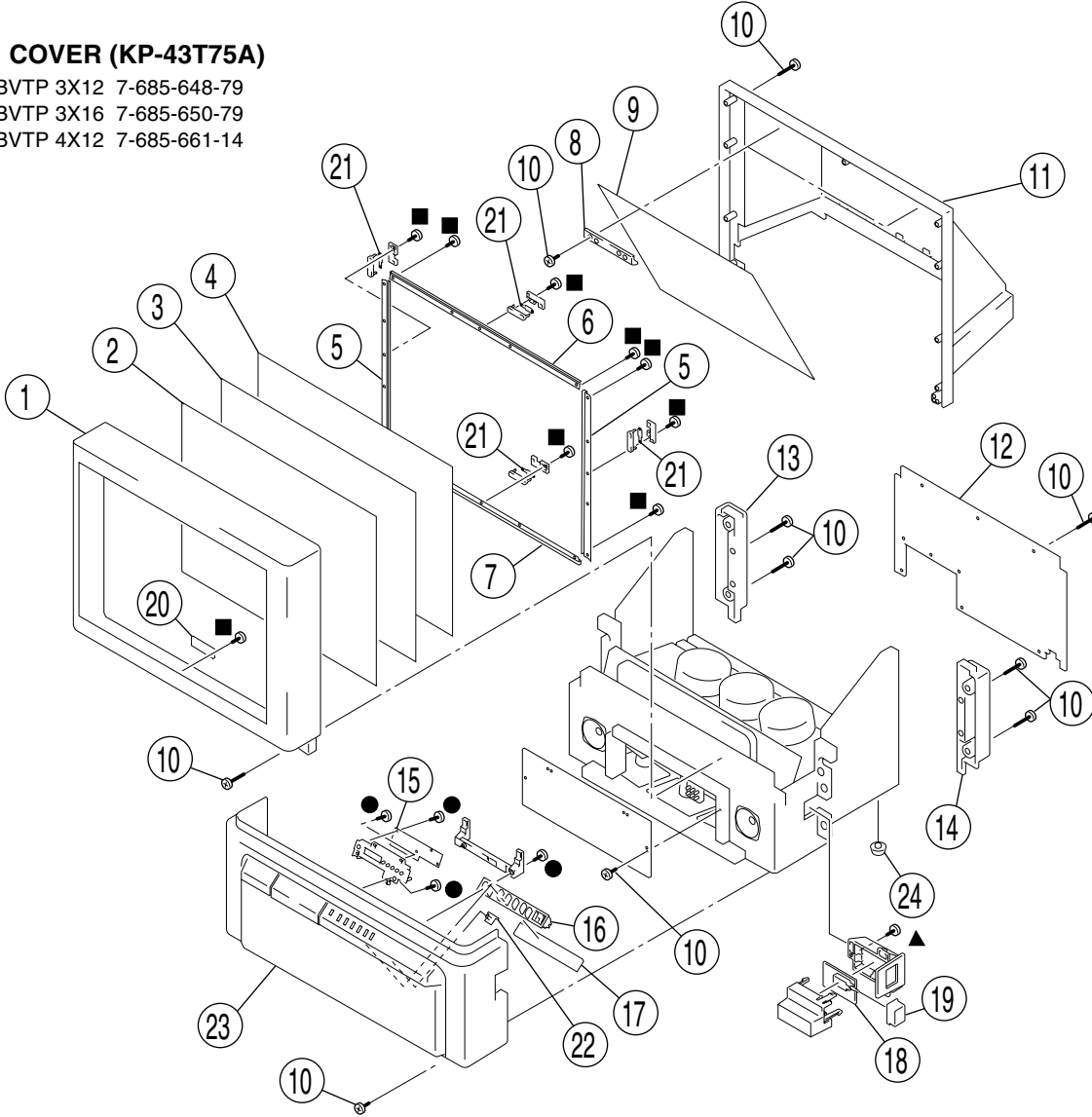

REF. NO.	PART NO.	DESCRIPTION	REMARK	REF. NO.	PART NO.	DESCRIPTION	REMARK
1	* X-4036-892-1	BEZNET ASSY		13	4-069-703-01	CAP (L), CONTROL	
2	4-070-286-11	SCREEN (43), CONTRAST		14	4-069-704-01	CAP (R), CONTROL	
3	4-070-284-11	PLATE (L), DIFFUSION		15	* A-1372-620-A	HB BOARD, COMPLETE	
4	4-070-285-11	PLATE (43F), DIFFUSION		16	4-069-681-21	BUTTON, MULTI	
5	* 4-070-332-31	HOLDER (L), SCREEN (NC)		17	* A-1372-762-A	HA BOARD, COMPLETE	
6	* 4-070-333-21	HOLDER (S), SCREEN (NC)		18	A-1241-389-A	FB BOARD, COMPLETE	
7	* 4-070-333-31	HOLDER (S), SCREEN (NC)		19	4-048-200-11	BUTTON, MAIN PANEL	
8	* 4-069-686-01	HOLDER, MIRROR		20	* A-1372-618-A	HC BOARD, COMPLETE	
9	4-077-051-01	MIRROR (43T), REFLECTION		21	* A-1390-933-A	S BOARD, COMPLETE	
10	4-378-522-31	SCREW (4X20), TAPPING		22	4-069-682-01	GUIDE, LED	
11	* 4-069-696-03	COVER (43), MIRROR		23	* X-4037-330-2	PANEL ASSY, CONTROL	
12	* 4-071-387-02	BOARD, REAR		24	4-057-611-01	FOOT	

7-2. COVER (KP-53SV75A)

● : +BVTP 3X12 7-685-648-79

■ : +BVTP 4X12 7-685-661-14

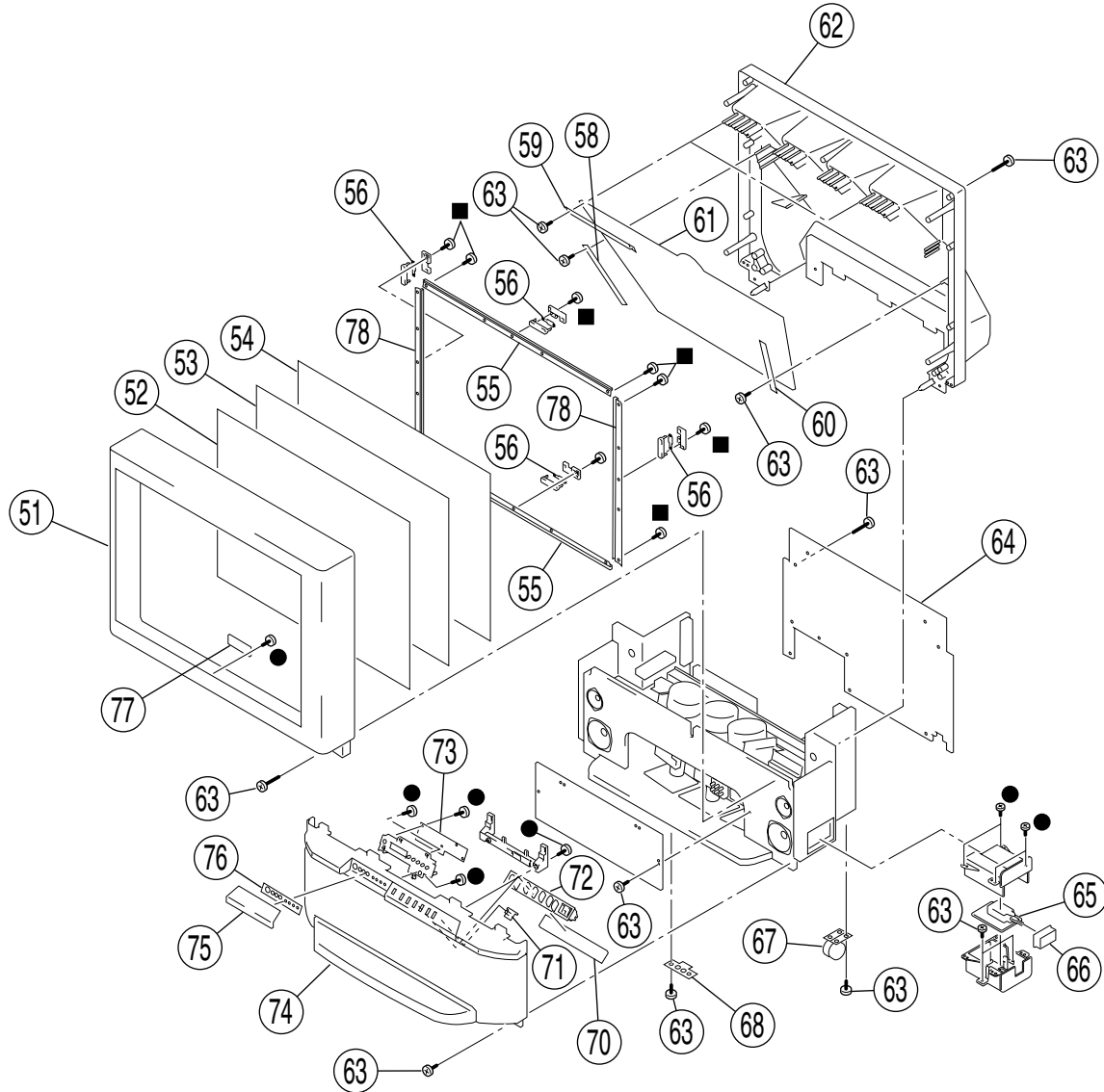

REF. NO.	PART NO.	DESCRIPTION	REMARK	REF. NO.	PART NO.	DESCRIPTION	REMARK
51	X-4036-809-1	BEZNET ASSY (53V)		66	4-048-200-02	BUTTON, MAIN PANEL	
52	4-058-894-11	SCREEN (53), CONTRAST		67	4-040-755-01	CASTER (DIA. 30)	
53	4-070-525-01	PLATE (L), DIFFUSION		68	4-048-175-01	FOOT, PLASTIC	
54	4-070-602-11	PLATE (F), DIFFUSION		70	* A-1372-762-A	HA BOARD, COMPLETE	
55	* 4-070-328-11	HOLDER (L), SCREEN (YC)		71	4-069-682-01	GUIDE, LED	
56	* A-1390-933-A	S BOARD, COMPLETE		72	4-069-681-11	BUTTON, MULTI	
58	* 4-069-687-01	HOLDER (LS), MIRROR		73	* A-1372-620-A	HB BOARD, COMPLETE	
59	* 4-070-345-11	HOLDER (TOP), MIRROR		74	X-4037-071-1	GRILLE ASSY, SPEAKER	
60	* 4-069-688-01	HOLDER (RS), MIRROR		75	4-069-671-01	DOOR (V), CONTROL	
61	4-070-344-01	MIRROR, REFLECTION		76	4-069-715-01	LABEL, CONTROL	
62	* 4-069-694-01	COVER, MIRROR		77	* A-1372-618-A	HC BOARD, COMPLETE	
63	4-378-522-31	SCREW (4X20), TAPPING		78	* 4-070-330-01	HOLDER (S), SCREEN (YC)	
64	* 4-070-342-01	BOARD (53), REAR					
65	A-1241-389-A	FB BOARD, COMPLETE					

The components identified by shading and mark \triangle are critical for safety. Replace only with part number specified.

7-3. CHASSIS (KP-43T75A)

● : +BVTP 3X12 7-685-648-79

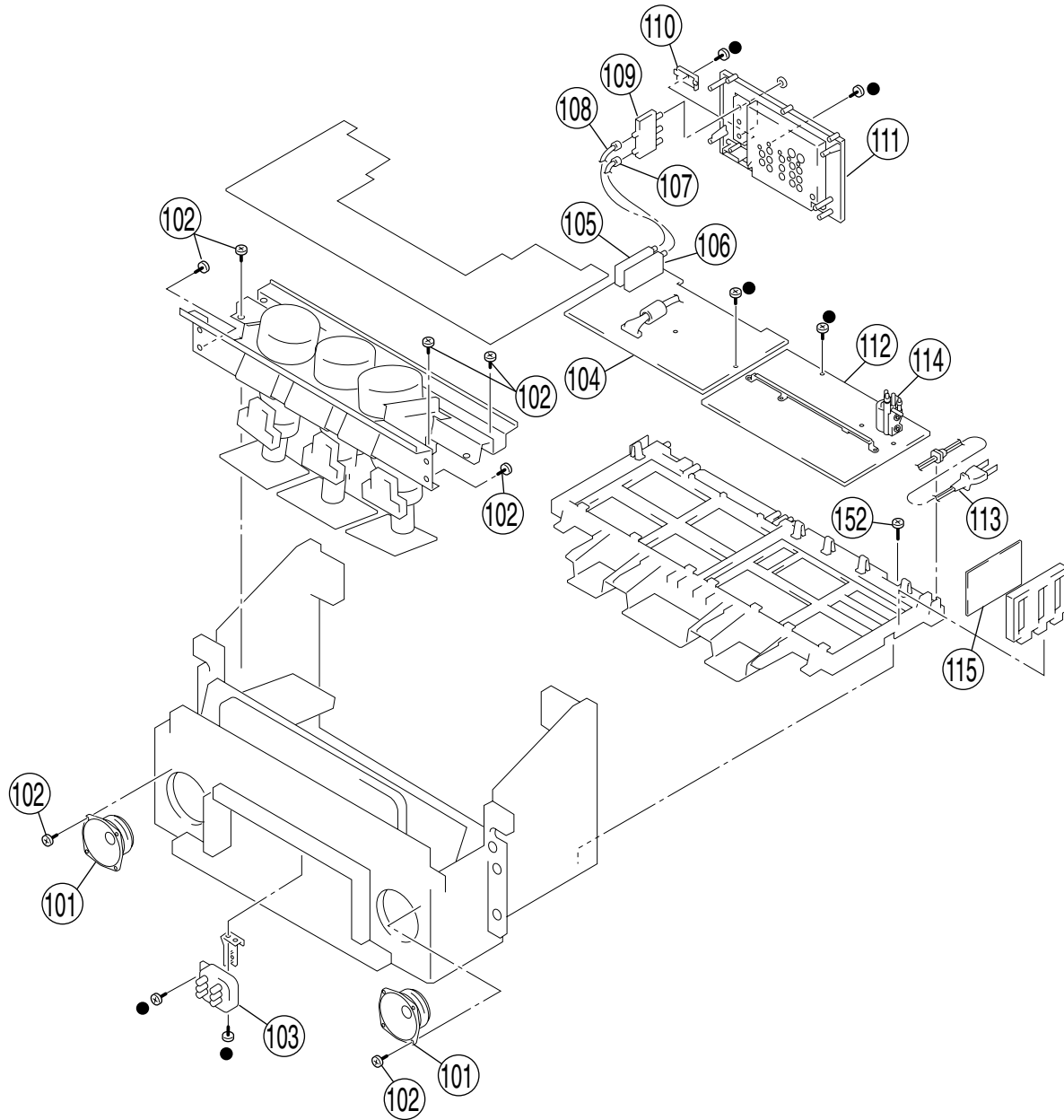

<u>REF. NO.</u>	<u>PART NO.</u>	<u>DESCRIPTION</u>	<u>REMARK</u>	<u>REF. NO.</u>	<u>PART NO.</u>	<u>DESCRIPTION</u>	<u>REMARK</u>
101	1-529-396-11	SPEAKER (10CM)		108	1-556-945-21	CABLE, P-P	
102	4-378-522-31	SCREW (4X20), TAPPING		109	\triangle 8-598-414-20	CHANGER, ANTENNA AS-2F	
103	\triangle 1-223-925-11	RESISTOR ASSY (HIGH-VOLTAGE) (FOCUS PACK)		110	4-069-675-01	CAP, TERMINAL BOARD	
104	* A-1298-990-A	A BOARD, COMPLETE		111	4-069-674-11	TERMINAL BOARD	
105	8-598-431-20	TUNER, SFF BTF-WA411 (TU151)		112	* A-1316-478-A	G BOARD, COMPLETE	
106	8-598-430-00	TUNER, SFF BTF-FA401 (TU152)		113	\triangle 1-783-838-11	CORD, POWER (WITH CONNECTOR)	
107	* 1-557-056-31	CABLE, P-P		114	\triangle 1-453-238-21	FBT ASSY (T504)	
				115	* A-1241-390-A	FA BOARD, COMPLETE	

The components identified by shading and mark \triangle are critical for safety.
Replace only with part number specified.

7-4. CHASSIS (KP-53SV75A)

● : +BVTP 3X12 7-685-648-79

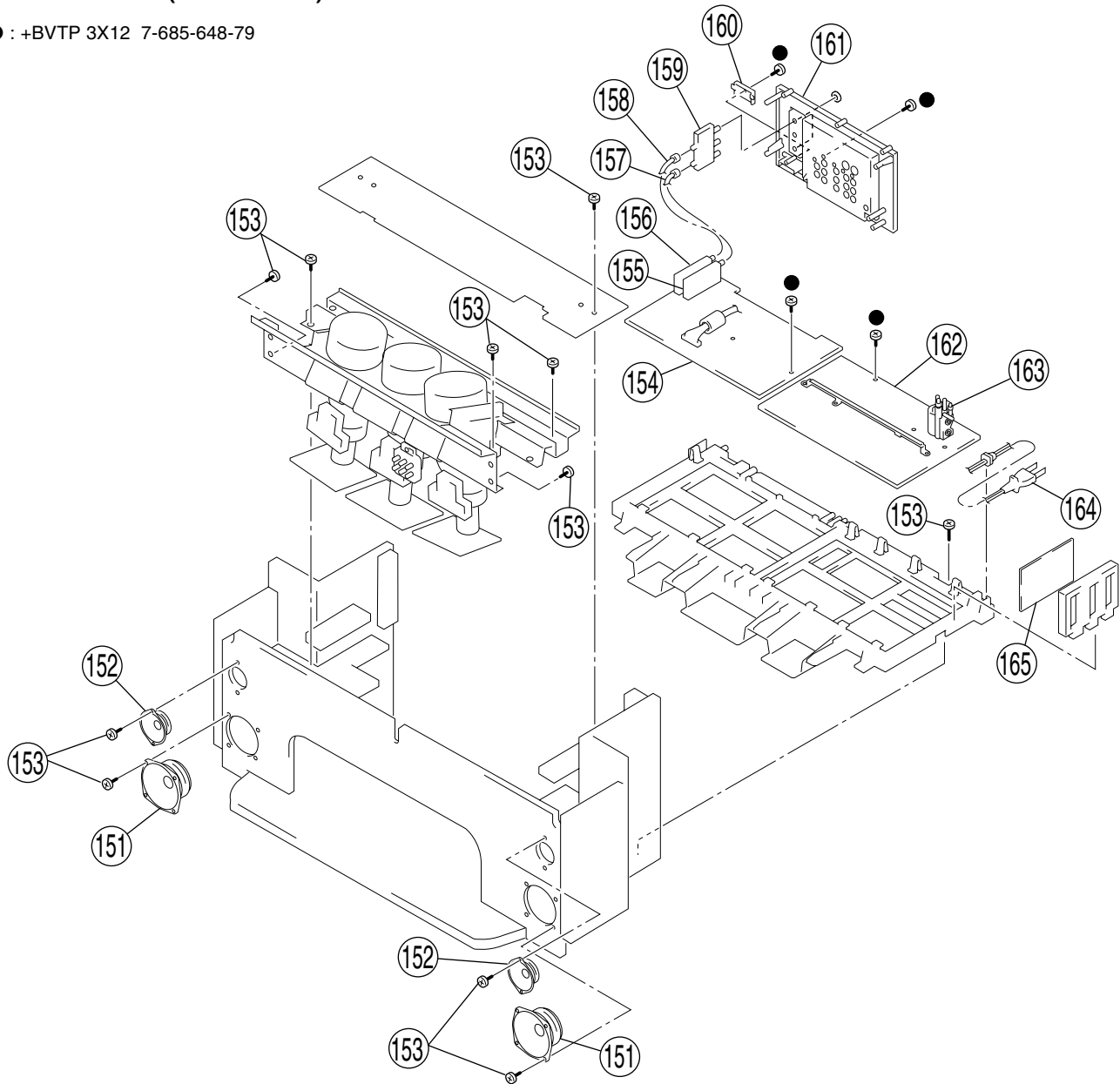

REF. NO.	PART NO.	DESCRIPTION	REMARK	REF. NO.	PART NO.	DESCRIPTION	REMARK
151	1-529-644-11	SPEAKER (16CM)		159	\triangle 8-598-414-20	CHANGER, ANTENNA AS-2F	
152	1-529-403-21	SPEAKER (6.6CM)		160	4-069-675-01	CAP, TERMINAL BOARD	
153	4-378-522-31	SCREW (4X20), TAPPING		161	4-069-674-11	TERMINAL BOARD	
154	* A-1298-990-AA	BOARD, COMPLETE		162	* A-1316-479-A	G BOARD, COMPLETE	
155	8-598-430-00	TUNER, SFF BTF-FA401 (TU152)		163	\triangle 1-453-238-21	FBT ASSY (T504)	
156	8-598-431-20	TUNER, SFF BTF-WA411 (TU151)		164	\triangle 1-783-838-11	CORD, POWER (WITH CONNECTOR)	
157	* 1-557-056-31	CABLE, P-P		165	* A-1241-390-A	FA BOARD, COMPLETE	
158	1-556-945-21	CABLE, P-P					

The components identified by shading and mark \triangle are critical for safety. Replace only with part number specified.

7-5. PICTURE TUBE

● : +BVTP 3X12 7-685-648-79

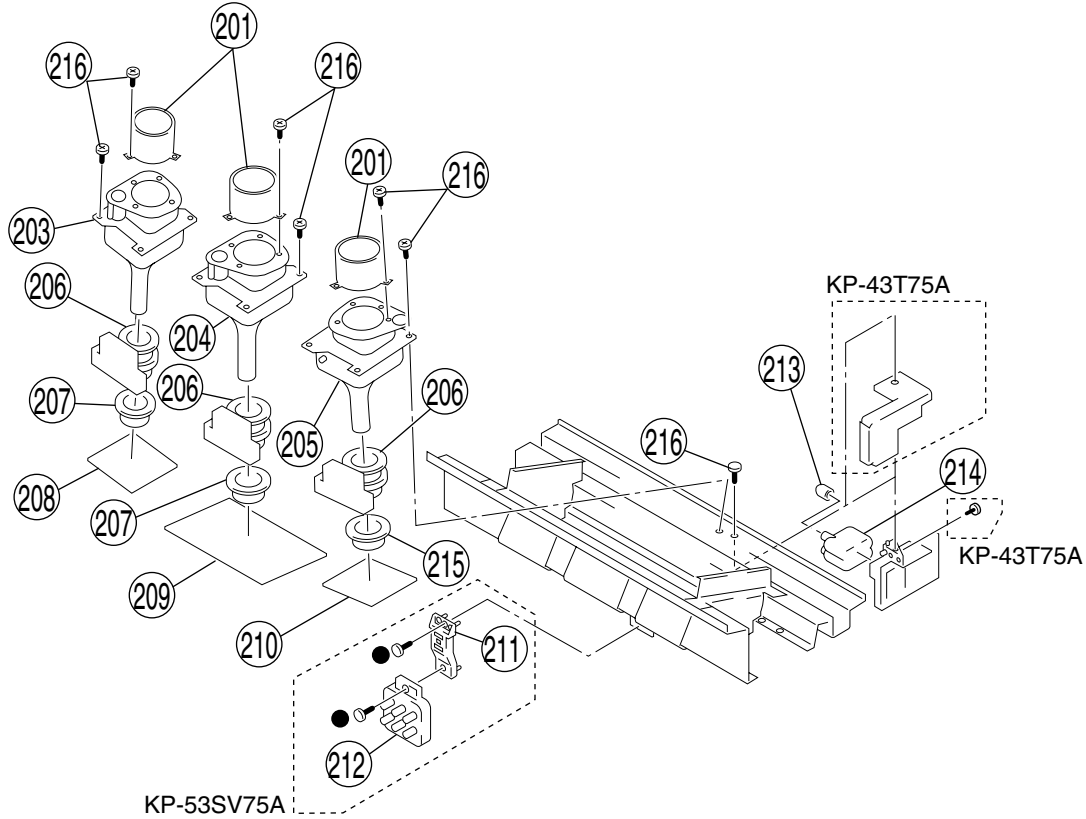

REF. NO.	PART NO.	DESCRIPTION	REMARK	REF. NO.	PART NO.	DESCRIPTION	REMARK
201	4-056-258-01	LENS (DELTA 78)		210	* A-1331-924-A	CB BOARD, COMPLETE	
203	\triangle 8-733-571-15	CRT 07MXC2(R)(HEATER) (43T75A)		211	* 4-063-403-01	BRACKET, FOCUS PACK (53SV75A)	
204	\triangle 8-733-572-15	CRT 07MXC3(R)(HEATER) (53SV75A)		212	\triangle 1-223-925-11	RESISTOR ASSY (HIGH-VOLTAGE) (FOCUS PACK) (53SV75A)	
205	\triangle 8-733-570-15	CRT 07MXC2(G)(HEATER)		213	4-373-137-01	CAP (Z), RUBBER	
	\triangle 8-733-574-15	CRT 07MAC2(B)(HEATER) (43T75A)		214	\triangle 8-598-955-30	BLOCK ASSY, HIGH-VOLTAGE	
205	\triangle 8-733-575-15	CRT 07MAC3(B)(HEATER) (53SV75A)		215	\triangle 1-452-909-31	MAGNET ASSY, 4 POLE	
206	\triangle 1-451-496-21	DEFLECTION YOKE		216	4-052-894-01	SCREW (4X20), HEAD TAPPING	
207	\triangle 1-452-790-21	NECK ASSY					
208	* A-1331-922-A	CR BOARD, COMPLETE					
209	* A-1331-923-A	CG BOARD, COMPLETE					

SECTION 8 ELECTRICAL PARTS LIST



The components identified by shading and mark Δ are critical for safety.
Replace only with part number specified.

When indicating parts by reference number, please include the board name.

- The components identified by in Δ this manual have been carefully factory-selected for each set in order to satisfy regulations regarding X-ray radiation. Should replacement be required, replace only with the value originally used.
 - Items marked " * " are not stocked since they are seldom required for routine service. Some delay should be anticipated when ordering these items.
 - All variable and adjustable resistors have characteristic curve B, unless otherwise noted.
- RESISTORS**
- All resistors are in ohms
 - F : nonflammable
- CAPACITORS
PF : $\mu\mu$ F
 - There are some cases the reference number on one board overlaps on the other board. Therefore, when ordering parts by the reference number, please include the board name.

REF. NO.	PART NO.	DESCRIPTION	REMARK	REF. NO.	PART NO.	DESCRIPTION	REMARK
* A-1241-390-A FA BOARD, COMPLETE *****				R6002 Δ	1-219-512-11	CARBON 2.2M	5% 1/2W
1-533-223-11 CLIP,FUSE				R6003 Δ	1-240-881-11	CMT,MELF 0.82	5% 20W
<CAPACITOR>				R6004 Δ	1-205-998-11	CEMENTED 1	5% 10W
C6001 Δ	1-104-706-11	MYLAR 0.22 μ F	20% 250V	R6005 Δ	1-240-881-11	CMT,MELF 0.82	5% 20W
C6002 Δ	1-104-706-11	MYLAR 0.22 μ F	20% 250V	<VARISTOR>			
C6003	1-119-886-51	CERAMIC 470pF	10% 250V	VD6001 Δ	1-801-073-31	VARISTORTNR14V471K660	
C6005	1-119-886-51	CERAMIC 470pF	10% 250V	VD6003	1-803-614-11	VARISTOR	
C6010	1-119-894-51	CERAMIC 0.0022 μ F	20% 250V	*****			
C6011	1-119-894-51	CERAMIC 0.0022 μ F	20% 250V	* A-1241-389-A FB BOARD, COMPLETE *****			
C6012	1-119-894-51	CERAMIC 0.0022 μ F	20% 250V	<CONNECTOR>			
<CONNECTOR>				CN6008*	1-580-689-11	PIN, CONNECTOR (PC BOARD) 4P	
CN6001*	1-580-689-11	PIN, CONNECTOR (PC BOARD) 4P		CN6009*	1-580-689-11	PIN, CONNECTOR (PC BOARD) 4P	
CN6002*	1-580-843-11	PIN, CONNECTOR (POWER)		<SWITCH>			
CN6003	1-695-915-11	TAB (CONTACT)		S6001 Δ	1-571-433-21	SWITCH, PUSH (AC POWER)	(MAIN POWER)
CN6004*	1-580-689-11	PIN, CONNECTOR (PC BOARD) 4P		*****			
CN6005*	1-691-291-11	PIN, CONNECTOR (PC BOARD) 5P		* A-1298-990-A A BOARD, COMPLETE *****			
CN6006*	1-580-837-11	PIN, CONNECTOR (PC BOARD) 3P		4-382-854-11	SCREW (M3X10), P, SW (+)		
CN6007	1-695-915-11	TAB (CONTACT)		<CAPACITOR>			
<DIODE>				C002	1-163-259-91	CERAMIC CHIP 220pF	5% 50V
D6001 Δ	8-719-510-53	DIODE D4SB60L		C003	1-164-004-11	CERAMIC CHIP 0.1 μ F	10% 25V
<FUSE>				C004	1-163-809-11	CERAMIC CHIP 0.047 μ F	10% 25V
F6001 Δ	1-532-506-51	FUSE 6.3A/250V		C005	1-126-935-11	ELECT 470 μ F	20% 6.3V
<COIL>				C006	1-126-960-11	ELECT 1 μ F	20% 50V
L6001 Δ	1-424-248-11	TRANSFORMER, LINE FILTER		C015	1-163-259-91	CERAMIC CHIP 220pF	5% 50V
L6002 Δ	1-424-248-11	TRANSFORMER, LINE FILTER		C016	1-163-809-11	CERAMIC CHIP 0.047 μ F	10% 25V
<RESISTOR>				C039	1-163-021-91	CERAMIC CHIP 0.01 μ F	10% 50V
R6001	1-218-265-11	METAL 8.2M	5% 1W	C040	1-126-916-11	ELECT 1000 μ F	20% 6.3V
				C041	1-163-229-11	CERAMIC CHIP 12pF	5% 50V

KP-43T75A/53SV75A

RM-Y906 RM-Y906



REF. NO.	PART NO.	DESCRIPTION	REMARK	REF. NO.	PART NO.	DESCRIPTION	REMARK
C042	1-126-960-11	ELECT	1μF 20% 50V	C288	1-164-004-11	CERAMIC CHIP	0.1μF 10% 25V
C044	1-163-231-11	CERAMIC CHIP	15pF 5% 50V	C289	1-126-935-11	ELECT	470μF 20% 16V
C066	1-117-720-11	CERAMIC CHIP	4.7μF 10V	C291	1-126-961-11	ELECT	2.2μF 20% 50V
C072	1-163-021-91	CERAMIC CHIP	0.01μF 10% 50V	C293	1-163-017-00	CERAMIC CHIP	0.0047μF 10% 50V
C080	1-163-227-11	CERAMIC CHIP	10pF 0.5pF 50V	C294	1-136-177-00	MYLAR	1μF 5% 50V
C081	1-163-227-11	CERAMIC CHIP	10pF 0.5pF 50V	C300	1-163-021-91	CERAMIC CHIP	0.01μF 10% 50V
C082	1-163-227-11	CERAMIC CHIP	10pF 0.5pF 50V	C301	1-163-021-91	CERAMIC CHIP	0.01μF 10% 50V
C085	1-163-021-91	CERAMIC CHIP	0.01μF 10% 50V	C302	1-163-021-91	CERAMIC CHIP	0.01μF 10% 50V
C086	1-163-229-11	CERAMIC CHIP	12pF 5% 50V	C303	1-163-021-91	CERAMIC CHIP	0.01μF 10% 50V
C087	1-126-964-11	ELECT	10μF 20% 50V	C304	1-126-933-11	ELECT	100μF 20% 16V
C091	1-163-227-11	CERAMIC CHIP	10pF 0.5pF 50V	C305	1-126-960-11	ELECT	1μF 20% 50V
C093	1-104-665-11	ELECT	100μF 20% 25V	C306	1-163-125-00	CERAMIC CHIP	220pF 5% 50V
C094	1-164-004-11	CERAMIC CHIP	0.1μF 10% 25V	C307	1-126-957-11	ELECT	0.22μF 20% 50V
C098	1-163-227-11	CERAMIC CHIP	10pF 0.5pF 50V	C308	1-126-959-11	ELECT	0.47μF 20% 50V
C099	1-163-227-11	CERAMIC CHIP	10pF 0.5pF 50V	C309	1-163-038-91	CERAMIC CHIP	0.1μF 25V
C100	1-163-227-11	CERAMIC CHIP	10pF 0.5pF 50V	C310	1-163-233-11	CERAMIC CHIP	18pF 5% 50V
C102	1-163-239-11	CERAMIC CHIP	33pF 5% 50V	C311	1-163-233-11	CERAMIC CHIP	18pF 5% 50V
C103	1-163-239-11	CERAMIC CHIP	33pF 5% 50V	C312	1-163-233-11	CERAMIC CHIP	18pF 5% 50V
C104	1-163-227-11	CERAMIC CHIP	10pF 0.5pF 50V	C314	1-128-551-11	ELECT	22μF 20% 25V
C105	1-163-227-11	CERAMIC CHIP	10pF 0.5pF 50V	C315	1-163-245-11	CERAMIC CHIP	56pF 5% 50V
C106	1-163-227-11	CERAMIC CHIP	10pF 0.5pF 50V	C317	1-104-664-11	ELECT	47μF 20% 16V
C151	1-126-935-11	ELECT	470μF 20% 16V	C318	1-126-933-11	ELECT	100μF 20% 16V
C152	1-163-021-91	CERAMIC CHIP	0.01μF 10% 50V	C319	1-126-960-11	ELECT	1μF 20% 50V
C153	1-163-021-91	CERAMIC CHIP	0.01μF 10% 50V	C320	1-126-934-11	ELECT	220μF 20% 16V
C154	1-163-021-91	CERAMIC CHIP	0.01μF 10% 50V	C323	1-164-004-11	CERAMIC CHIP	0.1μF 10% 25V
C155	1-128-551-11	ELECT	22μF 20% 25V	C324	1-163-021-91	CERAMIC CHIP	0.01μF 10% 50V
C156	1-126-933-11	ELECT	100μF 20% 16V	C325	1-126-964-11	ELECT	10μF 20% 50V
C157	1-163-021-91	CERAMIC CHIP	0.01μF 10% 50V	C326	1-104-664-11	ELECT	47μF 20% 25V
C159	1-164-161-11	CERAMIC CHIP	0.0022μF 10% 50V	C327	1-164-004-11	CERAMIC CHIP	0.1μF 10% 25V
C161	1-126-968-11	ELECT	100μF 20% 50V	C328	1-163-021-91	CERAMIC CHIP	0.01μF 10% 50V
C162	1-126-960-11	ELECT	1μF 20% 50V	C329	1-128-551-11	ELECT	22μF 20% 25V
C163	1-126-959-11	ELECT	0.47μF 20% 50V	C330	1-164-004-11	CERAMIC CHIP	0.1μF 10% 25V
C164	1-128-551-11	ELECT	22μF 20% 25V	C331	1-128-551-11	ELECT	22μF 20% 25V
C165	1-128-551-11	ELECT	22μF 20% 25V	C332	1-164-004-11	CERAMIC CHIP	0.1μF 10% 25V
C166	1-163-021-91	CERAMIC CHIP	0.01μF 10% 50V	C333	1-126-963-11	ELECT	4.7μF 20% 50V
C167	1-126-935-11	ELECT	470μF 20% 16V	C334	1-163-021-91	CERAMIC CHIP	0.01μF 10% 50V
C168	1-163-021-91	CERAMIC CHIP	0.01μF 10% 50V	C418	1-126-964-11	ELECT	10μF 20% 50V
C170	1-163-021-91	CERAMIC CHIP	0.01μF 10% 50V	C427	1-126-964-11	ELECT	10μF 20% 50V
C171	1-126-933-11	ELECT	100μF 20% 16V	C433	1-126-963-11	ELECT	4.7μF 20% 50V
C172	1-126-964-11	ELECT	10μF 20% 50V	C437	1-130-489-00	MYLAR	0.033μF 5% 50V
C173	1-163-021-91	CERAMIC CHIP	0.01μF 10% 50V	C438	1-104-664-11	ELECT	47μF 20% 25V
C174	1-126-933-11	ELECT	100μF 20% 16V	C439	1-126-960-11	ELECT	1μF 20% 50V
C175	1-128-551-11	ELECT	22μF 20% 25V	C440	1-126-963-11	ELECT	4.7μF 20% 50V
C176	1-164-161-11	CERAMIC CHIP	0.0022μF 10% 50V	C441	1-130-477-00	MYLAR	0.0033μF 5% 50V
C177	1-126-959-11	ELECT	0.47μF 20% 50V	C442	1-130-489-00	MYLAR	0.033μF 5% 50V
C178	1-126-960-11	ELECT	1μF 20% 50V	C443	1-130-471-00	MYLAR	0.001μF 5% 50V
C179	1-163-021-91	CERAMIC CHIP	0.01μF 10% 50V	C444	1-126-963-11	ELECT	4.7μF 20% 50V
C180	1-163-021-91	CERAMIC CHIP	0.01μF 10% 50V	C445	1-126-963-11	ELECT	4.7μF 20% 50V
C276	1-163-251-11	CERAMIC CHIP	100pF 5% 50V	C446	1-130-477-00	MYLAR	0.0033μF 5% 50V
C279	1-126-959-11	ELECT	0.47μF 20% 50V	C447	1-130-489-00	MYLAR	0.033μF 5% 50V
C280	1-163-251-11	CERAMIC CHIP	100pF 5% 50V	C448	1-130-471-00	MYLAR	0.001μF 5% 50V
C283	1-104-664-11	ELECT	47μF 20% 25V	C449	1-164-004-11	CERAMIC CHIP	0.1μF 10% 25V
C284	1-163-021-91	CERAMIC CHIP	0.01μF 10% 50V	C450	1-126-963-11	ELECT	4.7μF 20% 50V
C285	1-163-021-91	CERAMIC CHIP	0.01μF 10% 50V	C451	1-126-933-11	ELECT	100μF 20% 16V
C286	1-163-021-91	CERAMIC CHIP	0.01μF 10% 50V	C453	1-164-004-11	CERAMIC CHIP	0.1μF 10% 25V
C287	1-126-963-11	ELECT	4.7μF 20% 50V	C454	1-130-489-00	MYLAR	0.033μF 5% 50V



REF. NO.	PART NO.	DESCRIPTION	REMARK	REF. NO.	PART NO.	DESCRIPTION	REMARK
C456	1-126-933-11	ELECT	100µF 20% 16V	C829	1-107-823-11	CERAMIC CHIP	0.47µF 10% 16V
C457	1-126-934-11	ELECT	220µF 20% 16V	C830	1-163-038-91	CERAMIC CHIP	0.1µF 25V
C458	1-164-004-11	CERAMIC CHIP	0.1µF 10% 25V	C831	1-104-664-11	ELECT	47µF 20% 25V
C459	1-164-004-11	CERAMIC CHIP	0.1µF 10% 25V	C832	1-163-235-11	CERAMIC CHIP	22pF 5% 50V
C460	1-126-943-11	ELECT	2200µF 20% 25V	C833	1-104-664-11	ELECT	47µF 20% 25V
C461	1-126-943-11	ELECT	2200µF 20% 25V	C834	1-164-161-11	CERAMIC CHIP	0.0022µF 10% 50V
C462	1-126-961-11	ELECT	2.2µF 20% 50V	C835	1-163-235-11	CERAMIC CHIP	22pF 5% 50V
C463	1-126-961-11	ELECT	2.2µF 20% 50V	C842	1-164-004-11	CERAMIC CHIP	0.1µF 10% 25V
C464	1-126-933-11	ELECT	100µF 20% 16V	C843	1-104-664-11	ELECT	47µF 20% 25V
C465	1-128-551-11	ELECT	22µF 20% 25V	C845	1-163-038-91	CERAMIC CHIP	0.1µF 25V
C466	1-128-551-11	ELECT	22µF 20% 25V	C848	1-163-038-91	CERAMIC CHIP	0.1µF 25V
C467	1-104-664-11	ELECT	47µF 20% 25V	C849	1-104-664-11	ELECT	47µF 20% 25V
C468	1-126-963-11	ELECT	4.7µF 20% 50V	C850	1-104-664-11	ELECT	47µF 20% 25V
C469	1-128-551-11	ELECT	22µF 20% 25V	C851	1-163-038-91	CERAMIC CHIP	0.1µF 25V
C470	1-104-664-11	ELECT	47µF 20% 25V	C852	1-104-664-11	ELECT	47µF 20% 25V
C473	1-104-665-11	ELECT	100µF 20% 25V	C853	1-163-038-91	CERAMIC CHIP	0.1µF 25V
C474	1-130-495-00	MYLAR	0.1µF 5% 50V	C854	1-163-038-91	CERAMIC CHIP	0.1µF 25V
C475	1-130-495-00	MYLAR	0.1µF 5% 50V	C855	1-163-001-11	CERAMIC CHIP	220pF 10% 50V
C476	1-130-495-00	MYLAR	0.1µF 5% 50V	C856	1-104-664-11	ELECT	47µF 20% 25V
C477	1-130-495-00	MYLAR	0.1µF 5% 50V	C858	1-163-038-91	CERAMIC CHIP	0.1µF 25V
C517	1-126-964-11	ELECT	10µF 20% 50V	C862	1-164-004-11	CERAMIC CHIP	0.1µF 10% 25V
C681	1-126-935-11	ELECT	470µF 20% 16V	C863	1-163-231-11	CERAMIC CHIP	15pF 5% 50V
C682	1-163-021-91	CERAMIC CHIP	0.01µF 10% 50V	C864	1-163-239-11	CERAMIC CHIP	33pF 5% 50V
C683	1-126-935-11	ELECT	470µF 20% 16V	C865	1-164-004-11	CERAMIC CHIP	0.1µF 10% 25V
C684	1-126-933-11	ELECT	100µF 20% 16V	C866	1-163-038-91	CERAMIC CHIP	0.1µF 25V
C685	1-163-021-91	CERAMIC CHIP	0.01µF 10% 50V	C867	1-109-982-11	CERAMIC CHIP	1µF 10% 10V
C686	1-163-021-91	CERAMIC CHIP	0.01µF 10% 50V	C868	1-163-038-91	CERAMIC CHIP	0.1µF 25V
C687	1-128-551-11	ELECT	22µF 20% 25V	C869	1-163-021-91	CERAMIC CHIP	0.01µF 10% 50V
C688	1-163-021-91	CERAMIC CHIP	0.01µF 10% 50V	C870	1-104-664-11	ELECT	47µF 20% 25V
C801	1-163-143-00	CERAMIC CHIP	0.0012µF 5% 50V	C871	1-126-963-11	ELECT	4.7µF 20% 50V
C802	1-163-016-00	CERAMIC CHIP	0.0039µF 10% 50V	C872	1-163-239-11	CERAMIC CHIP	33pF 5% 50V
C803	1-163-016-00	CERAMIC CHIP	0.0039µF 10% 50V	C873	1-163-038-91	CERAMIC CHIP	0.1µF 25V
C804	1-163-038-91	CERAMIC CHIP	0.1µF 25V	C875	1-104-664-11	ELECT	47µF 20% 25V
C805	1-163-038-91	CERAMIC CHIP	0.1µF 25V	C876	1-163-038-91	CERAMIC CHIP	0.1µF 25V
C806	1-104-664-11	ELECT	47µF 20% 25V	C877	1-104-664-11	ELECT	47µF 20% 25V
C807	1-163-038-91	CERAMIC CHIP	0.1µF 25V	C878	1-104-664-11	ELECT	47µF 20% 25V
C808	1-163-016-00	CERAMIC CHIP	0.0039µF 10% 50V	C879	1-104-664-11	ELECT	47µF 20% 25V
C809	1-163-016-00	CERAMIC CHIP	0.0039µF 10% 50V	C880	1-163-038-91	CERAMIC CHIP	0.1µF 25V
C810	1-163-038-91	CERAMIC CHIP	0.1µF 25V	C881	1-163-038-91	CERAMIC CHIP	0.1µF 25V
C811	1-104-664-11	ELECT	47µF 20% 25V	C882	1-163-038-91	CERAMIC CHIP	0.1µF 25V
C812	1-163-038-91	CERAMIC CHIP	0.1µF 25V	C883	1-104-664-11	ELECT	47µF 20% 25V
C813	1-104-664-11	ELECT	47µF 20% 25V	C884	1-104-664-11	ELECT	47µF 20% 25V
C814	1-163-259-91	CERAMIC CHIP	220pF 5% 50V	C885	1-104-664-11	ELECT	47µF 20% 25V
C815	1-163-259-91	CERAMIC CHIP	220pF 5% 50V	C886	1-104-664-11	ELECT	47µF 20% 25V
C816	1-163-038-91	CERAMIC CHIP	0.1µF 25V	C887	1-104-664-11	ELECT	47µF 20% 25V
C817	1-163-038-91	CERAMIC CHIP	0.1µF 25V	C888	1-104-664-11	ELECT	47µF 20% 25V
C818	1-163-259-91	CERAMIC CHIP	220pF 5% 50V	C889	1-163-038-91	CERAMIC CHIP	0.1µF 25V
C819	1-163-259-91	CERAMIC CHIP	220pF 5% 50V	C890	1-104-664-11	ELECT	47µF 20% 25V
C820	1-163-038-91	CERAMIC CHIP	0.1µF 25V	C891	1-163-038-91	CERAMIC CHIP	0.1µF 25V
C821	1-104-664-11	ELECT	47µF 20% 25V	C892	1-104-664-11	ELECT	47µF 20% 25V
C822	1-163-038-91	CERAMIC CHIP	0.1µF 25V	C893	1-163-038-91	CERAMIC CHIP	0.1µF 25V
C823	1-104-664-11	ELECT	47µF 20% 25V	C894	1-104-664-11	ELECT	47µF 20% 25V
C824	1-164-004-11	CERAMIC CHIP	0.1µF 10% 25V	C897	1-163-038-91	CERAMIC CHIP	0.1µF 25V
C825	1-163-038-91	CERAMIC CHIP	0.1µF 25V	C898	1-126-934-11	ELECT	220µF 20% 16V
C826	1-107-823-11	CERAMIC CHIP	0.47µF 10% 16V	C899	1-163-222-11	CERAMIC CHIP	5pF 0.25pF 50V
C827	1-107-823-11	CERAMIC CHIP	0.47µF 10% 16V	C900	1-163-222-11	CERAMIC CHIP	5pF 0.25pF 50V
C828	1-107-823-11	CERAMIC CHIP	0.47µF 10% 16V				



REF. NO.	PART NO.	DESCRIPTION	REMARK	REF. NO.	PART NO.	DESCRIPTION	REMARK
C901	1-163-222-11	CERAMIC CHIP	5pF 0.25pF 50V	C1101	1-126-935-11	ELECT	470µF 20% 16V
C902	1-163-222-11	CERAMIC CHIP	5pF 0.25pF 50V	C1102	1-164-004-11	CERAMIC CHIP	0.1µF 10% 25V
C903	1-163-222-11	CERAMIC CHIP	5pF 0.25pF 50V	C1103	1-164-004-11	CERAMIC CHIP	0.1µF 10% 25V
C904	1-163-222-11	CERAMIC CHIP	5pF 0.25pF 50V	C1104	1-164-004-11	CERAMIC CHIP	0.1µF 10% 25V
C905	1-163-222-11	CERAMIC CHIP	5pF 0.25pF 50V	C1105	1-128-551-11	ELECT	22µF 20% 25V
C906	1-163-222-11	CERAMIC CHIP	5pF 0.25pF 50V	C1106	1-128-551-11	ELECT	22µF 20% 25V
C907	1-163-222-11	CERAMIC CHIP	5pF 0.25pF 50V	C1107	1-126-959-11	ELECT	0.47µF 20% 50V
C908	1-163-222-11	CERAMIC CHIP	5pF 0.25pF 50V	C1108	1-128-551-11	ELECT	22µF 20% 25V
C909	1-163-222-11	CERAMIC CHIP	5pF 0.25pF 50V	C1109	1-126-959-11	ELECT	0.47µF 20% 50V
C910	1-163-222-11	CERAMIC CHIP	5pF 0.25pF 50V	C1110	1-126-959-11	ELECT	0.47µF 20% 50V
C911	1-164-690-91	CERAMIC CHIP	0.0022µF 5% 50V	C1111	1-126-959-11	ELECT	0.47µF 20% 50V
C912	1-104-664-11	ELECT	47µF 20% 25V	C1112	1-128-551-11	ELECT	22µF 20% 25V
C913	1-104-664-11	ELECT	47µF 20% 25V	C1113	1-128-551-11	ELECT	22µF 20% 25V
C914	1-104-664-11	ELECT	47µF 20% 25V	C1114	1-128-551-11	ELECT	22µF 20% 25V
C915	1-104-664-11	ELECT	47µF 20% 25V	C1115	1-126-959-11	ELECT	0.47µF 20% 50V
C916	1-104-664-11	ELECT	47µF 20% 25V	C1116	1-126-964-11	ELECT	10µF 20% 50V
C917	1-104-664-11	ELECT	47µF 20% 25V	C1117	1-126-964-11	ELECT	10µF 20% 50V
C918	1-163-275-11	CERAMIC CHIP	0.001µF 5% 50V	C1118	1-128-551-11	ELECT	22µF 20% 25V
C919	1-163-275-11	CERAMIC CHIP	0.001µF 5% 50V	C1119	1-126-964-11	ELECT	10µF 20% 50V
C920	1-163-275-11	CERAMIC CHIP	0.001µF 5% 50V	C1120	1-126-964-11	ELECT	10µF 20% 50V
C921	1-163-275-11	CERAMIC CHIP	0.001µF 5% 50V	C1121	1-126-960-11	ELECT	1µF 20% 50V
C922	1-163-275-11	CERAMIC CHIP	0.001µF 5% 50V	C1122	1-163-021-91	CERAMIC CHIP	0.01µF 10% 50V
C923	1-163-275-11	CERAMIC CHIP	0.001µF 5% 50V	C1123	1-128-551-11	ELECT	22µF 20% 25V
C926	1-163-021-91	CERAMIC CHIP	0.01µF 10% 50V	C1124	1-163-021-91	CERAMIC CHIP	0.01µF 10% 50V
C927	1-163-038-91	CERAMIC CHIP	0.1µF 25V	C1125	1-163-021-91	CERAMIC CHIP	0.01µF 10% 50V
C928	1-163-038-91	CERAMIC CHIP	0.1µF 25V	C1126	1-128-551-11	ELECT	22µF 20% 25V
C929	1-163-038-91	CERAMIC CHIP	0.1µF 25V	C1127	1-126-959-11	ELECT	0.47µF 20% 50V
C930	1-163-038-91	CERAMIC CHIP	0.1µF 25V	C1128	1-128-551-11	ELECT	22µF 20% 25V
C931	1-163-038-91	CERAMIC CHIP	0.1µF 25V	C1129	1-163-021-91	CERAMIC CHIP	0.01µF 10% 50V
C932	1-163-038-91	CERAMIC CHIP	0.1µF 25V	C1130	1-163-021-91	CERAMIC CHIP	0.01µF 10% 50V
C933	1-163-017-00	CERAMIC CHIP	0.0047µF 10% 50V	C1131	1-163-021-91	CERAMIC CHIP	0.01µF 10% 50V
C934	1-163-017-00	CERAMIC CHIP	0.0047µF 10% 50V	C1132	1-163-021-91	CERAMIC CHIP	0.01µF 10% 50V
C935	1-163-017-00	CERAMIC CHIP	0.0047µF 10% 50V	C1133	1-163-021-91	CERAMIC CHIP	0.01µF 10% 50V
C936	1-163-017-00	CERAMIC CHIP	0.0047µF 10% 50V	C1134	1-163-021-91	CERAMIC CHIP	0.01µF 10% 50V
C937	1-163-017-00	CERAMIC CHIP	0.0047µF 10% 50V	C1147	1-126-959-11	ELECT	0.47µF 20% 50V
C938	1-163-017-00	CERAMIC CHIP	0.0047µF 10% 50V	C1148	1-163-021-91	CERAMIC CHIP	0.01µF 10% 50V
C951	1-163-019-00	CERAMIC CHIP	0.0068µF 10% 50V	C1601	1-164-004-11	CERAMIC CHIP	0.1µF 10% 25V
C952	1-163-019-00	CERAMIC CHIP	0.0068µF 10% 50V	C1602	1-163-133-00	CERAMIC CHIP	470pF 5% 50V
C953	1-163-019-00	CERAMIC CHIP	0.0068µF 10% 50V	C1603	1-164-344-11	CERAMIC CHIP	0.068µF 10% 25V
C954	1-163-019-00	CERAMIC CHIP	0.0068µF 10% 50V	C1604	1-163-019-00	CERAMIC CHIP	0.0068µF 10% 50V
C955	1-163-019-00	CERAMIC CHIP	0.0068µF 10% 50V	C1605	1-164-004-11	CERAMIC CHIP	0.1µF 10% 25V
C956	1-163-019-00	CERAMIC CHIP	0.0068µF 10% 50V	C1607	1-164-004-11	CERAMIC CHIP	0.1µF 10% 25V
C957	1-163-038-91	CERAMIC CHIP	0.1µF 25V	C1608	1-163-239-11	CERAMIC CHIP	33pF 5% 50V
C958	1-163-038-91	CERAMIC CHIP	0.1µF 25V	C1619	1-163-021-91	CERAMIC CHIP	0.01µF 10% 50V
C959	1-163-038-91	CERAMIC CHIP	0.1µF 25V	C1620	1-104-664-11	ELECT	47µF 20% 25V
C960	1-163-038-91	CERAMIC CHIP	0.1µF 25V	C1701	1-128-551-11	ELECT	22µF 20% 25V
C961	1-163-038-91	CERAMIC CHIP	0.1µF 25V	C1702	1-163-021-91	CERAMIC CHIP	0.01µF 10% 50V
C962	1-163-038-91	CERAMIC CHIP	0.1µF 25V	C1703	1-163-021-91	CERAMIC CHIP	0.01µF 10% 50V
C963	1-104-664-11	ELECT	47µF 20% 25V	C1704	1-126-933-11	ELECT	100µF 20% 16V
C964	1-104-664-11	ELECT	47µF 20% 25V	C1705	1-163-021-91	CERAMIC CHIP	0.01µF 10% 50V
C965	1-104-664-11	ELECT	47µF 20% 25V	C1706	1-163-021-91	CERAMIC CHIP	0.01µF 10% 50V
C966	1-104-664-11	ELECT	47µF 20% 25V	C1707	1-128-551-11	ELECT	22µF 20% 25V
C967	1-104-664-11	ELECT	47µF 20% 25V	C1708	1-126-964-11	ELECT	10µF 20% 50V
C968	1-104-664-11	ELECT	47µF 20% 25V	C1709	1-163-021-91	CERAMIC CHIP	0.01µF 10% 50V
C969	1-163-038-91	CERAMIC CHIP	0.1µF 25V	C1710	1-163-257-11	CERAMIC CHIP	180pF 5% 50V
C970	1-163-038-91	CERAMIC CHIP	0.1µF 25V	C1711	1-163-021-91	CERAMIC CHIP	0.01µF 10% 50V
C971	1-104-664-11	ELECT	47µF 20% 25V				



REF. NO.	PART NO.	DESCRIPTION	REMARK	REF. NO.	PART NO.	DESCRIPTION	REMARK
C1712	1-126-964-11	ELECT	10µF 20% 50V	C1939	1-163-021-91	CERAMIC CHIP	0.01µF 10% 50V
C1714	1-163-021-91	CERAMIC CHIP	0.01µF 10% 50V	C1940	1-128-551-11	ELECT	22µF 20% 25V
C1715	1-163-021-91	CERAMIC CHIP	0.01µF 10% 50V	C1941	1-128-551-11	ELECT	22µF 20% 25V
C1716	1-163-021-91	CERAMIC CHIP	0.01µF 10% 50V	C1942	1-128-551-11	ELECT	22µF 20% 25V
C1717	1-163-021-91	CERAMIC CHIP	0.01µF 10% 50V	C1944	1-163-021-91	CERAMIC CHIP	0.01µF 10% 50V
C1719	1-163-231-11	CERAMIC CHIP	15pF 5% 50V	C1945	1-163-021-91	CERAMIC CHIP	0.01µF 10% 50V
C1720	1-163-021-91	CERAMIC CHIP	0.01µF 10% 50V	C1946	1-163-239-11	CERAMIC CHIP	33pF 5% 50V
C1721	1-163-021-91	CERAMIC CHIP	0.01µF 10% 50V	C1947	1-163-239-11	CERAMIC CHIP	33pF 5% 50V
C1722	1-126-964-11	ELECT	10µF 20% 50V	C1948	1-163-021-91	CERAMIC CHIP	0.01µF 10% 50V
C1724	1-163-021-91	CERAMIC CHIP	0.01µF 10% 50V	C1949	1-126-960-11	ELECT	1µF 20% 50V
C1725	1-163-021-91	CERAMIC CHIP	0.01µF 10% 50V	C1950	1-163-021-91	CERAMIC CHIP	0.01µF 10% 50V
C1726	1-126-964-11	ELECT	10µF 20% 50V	C1951	1-163-021-91	CERAMIC CHIP	0.01µF 10% 50V
C1727	1-104-664-11	ELECT	47µF 20% 25V	C1952	1-128-551-11	ELECT	22µF 20% 25V
C1728	1-126-964-11	ELECT	10µF 20% 50V	C1953	1-163-021-91	CERAMIC CHIP	0.01µF 10% 50V
C1729	1-163-021-91	CERAMIC CHIP	0.01µF 10% 50V	C1954	1-163-021-91	CERAMIC CHIP	0.01µF 10% 50V
C1730	1-126-959-11	ELECT	0.47µF 20% 50V	C1955	1-163-259-91	CERAMIC CHIP	220pF 5% 50V
C1731	1-163-231-11	CERAMIC CHIP	15pF 5% 50V	C1958	1-163-251-11	CERAMIC CHIP	100pF 5% 50V
C1732	1-163-231-11	CERAMIC CHIP	15pF 5% 50V	C1959	1-163-251-11	CERAMIC CHIP	100pF 5% 50V
C1735	1-163-127-00	CERAMIC CHIP	270pF 5% 50V	C1960	1-163-021-91	CERAMIC CHIP	0.01µF 10% 50V
C1901	1-164-004-11	CERAMIC CHIP	0.1µF 10% 25V	C1961	1-128-551-11	ELECT	22µF 20% 25V
C1902	1-164-004-11	CERAMIC CHIP	0.1µF 10% 25V	C1962	1-163-021-91	CERAMIC CHIP	0.01µF 10% 50V
C1903	1-164-004-11	CERAMIC CHIP	0.1µF 10% 25V	C1963	1-126-960-11	ELECT	1µF 20% 50V
C1904	1-163-021-91	CERAMIC CHIP	0.01µF 10% 50V	C1964	1-164-004-11	CERAMIC CHIP	0.1µF 10% 25V
C1905	1-128-551-11	ELECT	22µF 20% 25V	C1965	1-164-004-11	CERAMIC CHIP	0.1µF 10% 25V
C1906	1-164-489-11	CERAMIC CHIP	0.22µF 10% 16V	C1966	1-164-004-11	CERAMIC CHIP	0.1µF 10% 25V
C1907	1-163-251-11	CERAMIC CHIP	100pF 5% 50V	C1967	1-128-551-11	ELECT	22µF 20% 25V
C1908	1-163-021-91	CERAMIC CHIP	0.01µF 10% 50V	C1968	1-163-229-11	CERAMIC CHIP	12pF 5% 50V
C1909	1-164-489-11	CERAMIC CHIP	0.22µF 10% 16V	C1969	1-163-229-11	CERAMIC CHIP	12pF 5% 50V
C1910	1-163-021-91	CERAMIC CHIP	0.01µF 10% 50V	C1970	1-163-038-91	CERAMIC CHIP	0.1µF 25V
C1911	1-128-551-11	ELECT	22µF 20% 25V	C1971	1-163-038-91	CERAMIC CHIP	0.1µF 25V
C1912	1-164-004-11	CERAMIC CHIP	0.1µF 10% 25V	C1972	1-163-038-91	CERAMIC CHIP	0.1µF 25V
C1913	1-164-346-11	CERAMIC CHIP	1µF 16V	C1973	1-163-038-91	CERAMIC CHIP	0.1µF 25V
C1914	1-163-017-00	CERAMIC CHIP	0.0047µF 10% 50V	C1974	1-163-021-91	CERAMIC CHIP	0.01µF 10% 50V
C1915	1-164-346-11	CERAMIC CHIP	1µF 16V	C1975	1-163-021-91	CERAMIC CHIP	0.01µF 10% 50V
C1916	1-164-004-11	CERAMIC CHIP	0.1µF 10% 25V	C1976	1-163-021-91	CERAMIC CHIP	0.01µF 10% 50V
C1917	1-164-004-11	CERAMIC CHIP	0.1µF 10% 25V	C1977	1-163-021-91	CERAMIC CHIP	0.01µF 10% 50V
C1918	1-164-005-11	CERAMIC CHIP	0.47µF 16V	C1978	1-163-021-91	CERAMIC CHIP	0.01µF 10% 50V
C1919	1-164-004-11	CERAMIC CHIP	0.1µF 10% 25V	C5107	1-163-038-91	CERAMIC CHIP	0.1µF 25V
C1920	1-164-004-11	CERAMIC CHIP	0.1µF 10% 25V	C5167	1-126-964-11	ELECT	10µF 20% 50V
C1921	1-126-963-11	ELECT	4.7µF 20% 50V	C5172	1-163-038-91	CERAMIC CHIP	0.1µF 25V
C1922	1-164-004-11	CERAMIC CHIP	0.1µF 10% 25V	<JUMPER RESISTOR>			
C1923	1-163-005-11	CERAMIC CHIP	470pF 10% 50V	CJ001	1-216-295-00	SHORT	0
C1924	1-126-960-11	ELECT	1µF 20% 50V	CJ002	1-216-295-00	SHORT	0
C1925	1-164-005-11	CERAMIC CHIP	0.47µF 16V	CJ003	1-216-295-00	SHORT	0
C1926	1-128-551-11	ELECT	22µF 20% 25V	CJ004	1-216-295-00	SHORT	0
C1927	1-163-021-91	CERAMIC CHIP	0.01µF 10% 50V	<CONNECTOR>			
C1928	1-163-021-91	CERAMIC CHIP	0.01µF 10% 50V	CN001	* 1-564-507-11	PLUG, CONNECTOR	4P
C1929	1-163-021-91	CERAMIC CHIP	0.01µF 10% 50V	CN002	* 1-564-513-11	PLUG, CONNECTOR	10P
C1930	1-163-229-11	CERAMIC CHIP	12pF 5% 50V	CN003	1-573-979-21	CONNECTOR, BOARD TO BOARD	11P
C1931	1-163-021-91	CERAMIC CHIP	0.01µF 10% 50V	CN151	1-695-915-11	TAB (CONTACT)	
C1932	1-128-551-11	ELECT	22µF 20% 25V	CN202	* 1-779-892-11	CONNECTOR, BOARD TO BOARD	10P
C1933	1-164-004-11	CERAMIC CHIP	0.1µF 10% 25V	CN203	* 1-564-509-11	PLUG, CONNECTOR	6P
C1934	1-164-004-11	CERAMIC CHIP	0.1µF 10% 25V	CN204	* 1-564-512-11	PLUG, CONNECTOR	9P
C1935	1-164-004-11	CERAMIC CHIP	0.1µF 10% 25V	CN205	1-695-915-11	TAB (CONTACT)	
C1936	1-163-021-91	CERAMIC CHIP	0.01µF 10% 50V				
C1937	1-128-551-11	ELECT	22µF 20% 25V				
C1938	1-163-021-91	CERAMIC CHIP	0.01µF 10% 50V				



REF. NO.	PART NO.	DESCRIPTION	REMARK	REF. NO.	PART NO.	DESCRIPTION	REMARK
CN402 *	1-779-892-11	CONNECTOR, BOARD TO BOARD 10P		D818	8-719-988-61	DIODE 1SS355TE-17	
CN403 *	1-564-507-11	PLUG, CONNECTOR 4P		D819	8-719-988-61	DIODE 1SS355TE-17	
CN681 *	1-779-892-11	CONNECTOR, BOARD TO BOARD 10P		D820	8-719-988-61	DIODE 1SS355TE-17	
CN801 *	1-779-892-11	CONNECTOR, BOARD TO BOARD 10P		D821	8-719-988-61	DIODE 1SS355TE-17	
CN802 *	1-564-511-11	PLUG, CONNECTOR 8P		D822	8-719-988-61	DIODE 1SS355TE-17	
CN1702	1-764-334-11	PLUG, CONNECTOR 11P		D823	8-719-988-61	DIODE 1SS355TE-17	
		<DIODE>		D824	8-719-988-61	DIODE 1SS355TE-17	
D001	8-719-988-61	DIODE 1SS355TE-17		D1101	8-719-069-55	DIODE UDZS-TE17-5.6B	
D002	8-719-988-61	DIODE 1SS355TE-17		D1102	8-719-977-28	DIODE DTZ10B	
D003	8-719-988-61	DIODE 1SS355TE-17		D1103	8-719-977-28	DIODE DTZ10B	
D004	8-719-069-55	DIODE UDZS-TE17-5.6B		D1104	8-719-977-28	DIODE DTZ10B	
D005	8-719-988-61	DIODE 1SS355TE-17		D1105	8-719-977-28	DIODE DTZ10B	
D006	8-719-069-55	DIODE UDZS-TE17-5.6B		D1106	8-719-977-28	DIODE DTZ10B	
D007	8-719-069-55	DIODE UDZS-TE17-5.6B		D1107	8-719-977-28	DIODE DTZ10B	
D009	8-719-069-55	DIODE UDZS-TE17-5.6B		D1108	8-719-977-28	DIODE DTZ10B	
D010	8-719-069-55	DIODE UDZS-TE17-5.6B		D1109	8-719-977-28	DIODE DTZ10B	
D151	8-719-977-81	DIODE DTZ33B		D1110	8-719-977-28	DIODE DTZ10B	
D202	8-719-977-28	DIODE DTZ10B		D1111	8-719-977-28	DIODE DTZ10B	
D206	8-719-988-61	DIODE 1SS355TE-17		D1112	8-719-977-28	DIODE DTZ10B	
D207	8-719-988-61	DIODE 1SS355TE-17		D1113	8-719-977-28	DIODE DTZ10B	
D301	8-719-988-61	DIODE 1SS355TE-17		D1114	8-719-977-28	DIODE DTZ10B	
D302	8-719-988-61	DIODE 1SS355TE-17		D1115	8-719-977-28	DIODE DTZ10B	
D303	8-719-988-61	DIODE 1SS355TE-17		D1116	8-719-977-28	DIODE DTZ10B	
D304	8-719-069-59	DIODE UDZS-TE17-8.2B		D1117	8-719-977-28	DIODE DTZ10B	
D305	8-719-977-28	DIODE DTZ10B		D1118	8-719-977-28	DIODE DTZ10B	
D306	8-719-422-12	DIODE MA8039		D1119	8-719-977-28	DIODE DTZ10B	
D307	8-719-988-61	DIODE 1SS355TE-17		D1120	8-719-988-61	DIODE 1SS355TE-17	
D402	8-719-988-61	DIODE 1SS355TE-17		D1121	8-719-977-28	DIODE DTZ10B	
D403	8-719-988-61	DIODE 1SS355TE-17		D1122	8-719-977-28	DIODE DTZ10B	
D404	8-719-988-61	DIODE 1SS355TE-17		D1123	8-719-988-61	DIODE 1SS355TE-17	
D405	8-719-988-61	DIODE 1SS355TE-17		D1124	8-719-988-61	DIODE 1SS355TE-17	
D406	8-719-056-95	DIODE UDZ-TE-17-22B		D1125	8-719-988-61	DIODE 1SS355TE-17	
D407	8-719-988-61	DIODE 1SS355TE-17		D1126	8-719-977-28	DIODE DTZ10B	
D408	8-719-988-61	DIODE 1SS355TE-17		D1127	8-719-977-28	DIODE DTZ10B	
D410	8-719-056-95	DIODE UDZ-TE-17-22B		D1901	8-719-988-61	DIODE 1SS355TE-17	
D411	8-719-056-95	DIODE UDZ-TE-17-22B		D1902	8-719-988-61	DIODE 1SS355TE-17	
D412	8-719-056-95	DIODE UDZ-TE-17-22B		D1903	8-719-988-61	DIODE 1SS355TE-17	
D413	8-719-056-95	DIODE UDZ-TE-17-22B		D1904	8-719-988-61	DIODE 1SS355TE-17	
D414	8-719-056-95	DIODE UDZ-TE-17-22B		D1905	8-719-988-61	DIODE 1SS355TE-17	
D415	8-719-056-95	DIODE UDZ-TE-17-22B				<FERRITE BEAD>	
D418	8-719-056-95	DIODE UDZ-TE-17-22B		FB001	1-414-135-11	FERRITE 0μH	
D420	8-719-988-61	DIODE 1SS355TE-17		FB004	1-410-397-21	FERRITE 1.1μH	
D421	8-719-988-61	DIODE 1SS355TE-17		FB151	1-414-135-11	FERRITE 0μH	
D801	8-719-988-61	DIODE 1SS355TE-17		FB152	1-414-135-11	FERRITE 0μH	
D802	8-719-988-61	DIODE 1SS355TE-17		FB206	1-216-017-91	RES,CHIP 47	5% 1/10W
D803	8-719-988-61	DIODE 1SS355TE-17		FB207	1-216-017-91	RES,CHIP 47	5% 1/10W
D804	8-719-988-61	DIODE 1SS355TE-17		FB209	1-216-017-91	RES,CHIP 47	5% 1/10W
D805	8-719-069-55	DIODE UDZS-TE17-5.6B		FB212	1-216-295-00	SHORT 0	
D806	8-719-069-55	DIODE UDZS-TE17-5.6B		FB215	1-216-295-00	SHORT 0	
D807	8-719-069-55	DIODE UDZS-TE17-5.6B		FB216	1-216-295-00	SHORT 0	
D808	8-719-069-55	DIODE UDZS-TE17-5.6B		FB217	1-216-295-00	SHORT 0	
D809	8-719-988-61	DIODE 1SS355TE-17		FB301	1-216-295-00	SHORT 0	
D810	8-719-988-61	DIODE 1SS355TE-17		FB801	1-414-135-11	FERRITE 0μH	
D816	8-719-988-61	DIODE 1SS355TE-17		FB802	1-414-135-11	FERRITE 0μH	
D817	8-719-988-61	DIODE 1SS355TE-17		FB803	1-414-135-11	FERRITE 0μH	



REF. NO.	PART NO.	DESCRIPTION	REMARK	REF. NO.	PART NO.	DESCRIPTION	REMARK
FB804	1-500-245-11	FERRITE	0μH	IC1603	8-759-352-91	IC PST9143NL	
FB805	1-500-245-11	FERRITE	0μH	IC1701	8-759-701-75	IC NJM7805FA	
FB806	1-414-135-11	FERRITE	0μH	IC1702	8-759-655-52	IC TC90A49F(ELP)	
FB807	1-414-135-11	FERRITE	0μH	IC1901	8-752-080-75	IC CXA2039M-T6	
FB808	1-414-135-11	FERRITE	0μH				
FB811	1-500-245-11	FERRITE	0μH	IC1902	8-752-086-80	IC CXA2019AQ-T4	
FB812	1-500-245-11	FERRITE	0μH	IC1903	8-759-932-69	IC BU4053BCF-T2	
FB813	1-500-245-11	FERRITE	0μH	IC1904	8-752-058-68	IC CXA1315M	
FB814	1-500-245-11	FERRITE	0μH	IC1905	8-759-533-89	IC SDA9288XE-GEG-B121	
FB887	1-414-551-11	FERRITE	0μH	IC5004	8-759-378-17	IC TDA4662T-V2	
FB1902	1-414-135-11	FERRITE	0μH			<JACK>	
		<FILTER>		J1101	1-774-751-11	TERMINAL BLOCK, S	
FL1701	1-239-847-11	FILTER, LOW PASS		J1102	1-774-751-11	TERMINAL BLOCK, S	
FL1702	1-239-847-11	FILTER, LOW PASS		J1103	1-507-667-00	JACK, MIC	
FL1703	1-239-847-11	FILTER, LOW PASS		J1104	1-774-750-11	JACK BLOCK, PIN	
		<IC>		J1105	1-774-749-11	JACK BLOCK, PIN	
IC001	8-759-352-91	IC PST9143NL		J1106	1-785-082-11	JACK BLOCK, PIN 3P	
IC002	8-752-911-96	IC CXP750010-016Q				<JUMPER RESISTOR>	
IC004	8-759-527-76	IC M24C08-MN6T		JR003	1-216-295-00	SHORT	0
IC206	8-752-090-40	IC CXA2135S		JR004	1-216-295-00	SHORT	0
IC301	8-759-239-25	IC TC74HC4066AF		JR018	1-216-295-00	SHORT	0
IC302	8-759-398-25	IC TC7SH04F(TE85L)		JR019	1-216-295-00	SHORT	0
IC403	8-759-578-88	IC BH3868FS-E2		JR020	1-216-295-00	SHORT	0
IC404	8-759-100-96	IC μPC4558G2		JR021	1-216-295-00	SHORT	0
IC406	8-759-190-89	IC TDA7265				<COIL>	
IC681	8-759-459-99	IC PQ09RD11		L001	1-414-183-41	INDUCTOR	10μH
IC682	8-759-459-99	IC PQ09RD11		L151	1-414-187-11	INDUCTOR	47μH
IC801	8-759-488-29	IC TC7W66FU(TE12R)		L152	1-414-187-11	INDUCTOR	47μH
IC802	8-759-394-80	IC NJM2058M-TE2		L153	1-414-187-11	INDUCTOR	47μH
IC803	8-759-589-66	IC CM0006CF		L154	1-414-183-41	INDUCTOR	10μH
IC804	8-759-394-80	IC NJM2058M-TE2		L155	1-414-187-11	INDUCTOR	47μH
IC805	8-752-911-98	IC CXP86324-025Q		L211	1-414-189-31	INDUCTOR	100μH
IC806	8-759-394-80	IC NJM2058M-TE2		L212	1-414-856-11	INDUCTOR	10μH
IC807	8-759-546-22	IC μPD6376GS-E2		L681	1-406-975-21	INDUCTOR	47μH
IC808	8-759-032-11	IC MC74HC04AF		L801	1-414-183-41	INDUCTOR	10μH
IC809	8-759-295-09	IC TLC2932IPW		L802	1-414-183-41	INDUCTOR	10μH
IC810	8-759-468-90	IC ST24E16FM6TR		L803	1-414-183-41	INDUCTOR	10μH
IC811	8-759-352-91	IC PST9143NL		L804	1-414-183-41	INDUCTOR	10μH
IC812	8-759-235-19	IC TC74HC08AF(EL)		L809	1-414-183-41	INDUCTOR	10μH
IC814	8-759-032-20	IC MC74HC32AF		L816	1-414-183-41	INDUCTOR	10μH
IC815	8-759-546-22	IC μPD6376GS-E2		L823	1-410-494-11	INDUCTOR	1mH
IC816	8-759-546-22	IC μPD6376GS-E2		L824	1-410-494-11	INDUCTOR	1mH
IC817	8-759-546-22	IC μPD6376GS-E2		L825	1-410-494-11	INDUCTOR	1mH
IC818	8-759-100-96	IC μPC4558G2		L826	1-410-494-11	INDUCTOR	1mH
IC819	8-759-106-02	IC μPC4570G2		L827	1-410-494-11	INDUCTOR	1mH
IC820	8-759-106-02	IC μPC4570G2		L828	1-410-494-11	INDUCTOR	1mH
IC821	8-759-106-02	IC μPC4570G2		L829	1-414-183-41	INDUCTOR	10μH
IC822	8-759-106-02	IC μPC4570G2		L830	1-407-495-00	INDUCTOR	1.8mH
IC823	8-759-106-02	IC μPC4570G2		L831	1-407-495-00	INDUCTOR	1.8mH
IC824	8-759-106-02	IC μPC4570G2		L832	1-407-495-00	INDUCTOR	1.8mH
IC1101	8-752-081-32	IC CXA2079Q		L833	1-407-495-00	INDUCTOR	1.8mH
IC1601	8-759-638-04	IC Z8622912SSC-00TR					



<u>REF. NO.</u>	<u>PART NO.</u>	<u>DESCRIPTION</u>	<u>REMARK</u>	<u>REF. NO.</u>	<u>PART NO.</u>	<u>DESCRIPTION</u>	<u>REMARK</u>
L834	1-407-495-00	INDUCTOR	1.8mH	Q303	8-729-422-27	TRANSISTOR	2SD601A-Q
L835	1-407-495-00	INDUCTOR	1.8mH	Q304	8-729-422-27	TRANSISTOR	2SD601A-Q
L843	1-414-183-41	INDUCTOR	10μH	Q305	8-729-900-53	TRANSISTOR	DTC114EKA
L1701	1-414-183-41	INDUCTOR	10μH	Q306	8-729-422-27	TRANSISTOR	2SD601A-Q
L5107	1-414-183-41	INDUCTOR	10μH	Q401	8-729-216-22	TRANSISTOR	2SA1162-G
L5108	1-414-183-41	INDUCTOR	10μH	Q402	8-729-216-22	TRANSISTOR	2SA1162-G
		<IC LINK>		Q403	8-729-422-27	TRANSISTOR	2SD601A-Q
PS401	1-532-984-11	LINK, IC	2A/90V	Q404	8-729-422-27	TRANSISTOR	2SD601A-Q
PS402	1-532-984-11	LINK, IC	2A/90V	Q408	8-729-422-27	TRANSISTOR	2SD601A-Q
		<TRANSISTOR>		Q409	8-729-422-27	TRANSISTOR	2SD601A-Q
Q001	8-729-216-22	TRANSISTOR	2SA1162-G	Q410	8-729-422-27	TRANSISTOR	2SD601A-Q
Q002	8-729-422-27	TRANSISTOR	2SD601A-Q	Q411	8-729-216-22	TRANSISTOR	2SA1162-G
Q003	8-729-027-38	TRANSISTOR	DTA144EKA-T146	Q801	1-801-806-11	TRANSISTOR	DTC144EKA-T146
Q004	8-729-216-22	TRANSISTOR	2SA1162-G	Q802	1-801-806-11	TRANSISTOR	DTC144EKA-T146
Q005	8-729-027-38	TRANSISTOR	DTA144EKA-T146	Q803	1-801-806-11	TRANSISTOR	DTC144EKA-T146
Q006	8-729-027-38	TRANSISTOR	DTA144EKA-T146	Q804	1-801-806-11	TRANSISTOR	DTC144EKA-T146
Q007	8-729-027-38	TRANSISTOR	DTA144EKA-T146	Q805	1-801-806-11	TRANSISTOR	DTC144EKA-T146
Q008	8-729-422-27	TRANSISTOR	2SD601A-Q	Q806	8-729-422-27	TRANSISTOR	2SD601A-Q
Q009	8-729-422-27	TRANSISTOR	2SD601A-Q	Q807	8-729-422-27	TRANSISTOR	2SD601A-Q
Q010	8-729-422-27	TRANSISTOR	2SD601A-Q	Q808	8-729-422-27	TRANSISTOR	2SD601A-Q
Q011	8-729-422-27	TRANSISTOR	2SD601A-Q	Q809	8-729-422-27	TRANSISTOR	2SD601A-Q
Q012	8-729-422-27	TRANSISTOR	2SD601A-Q	Q811	8-729-422-27	TRANSISTOR	2SD601A-Q
Q013	8-729-422-27	TRANSISTOR	2SD601A-Q	Q812	8-729-422-27	TRANSISTOR	2SD601A-Q
Q014	8-729-422-27	TRANSISTOR	2SD601A-Q	Q813	8-729-422-27	TRANSISTOR	2SD601A-Q
Q015	8-729-422-27	TRANSISTOR	2SD601A-Q	Q814	8-729-422-27	TRANSISTOR	2SD601A-Q
Q016	8-729-422-27	TRANSISTOR	2SD601A-Q	Q1101	8-729-027-56	TRANSISTOR	DTC143TKA-T146
Q017	8-729-422-27	TRANSISTOR	2SD601A-Q	Q1102	8-729-422-27	TRANSISTOR	2SD601A-Q
Q018	8-729-422-27	TRANSISTOR	2SD601A-Q	Q1103	8-729-422-27	TRANSISTOR	2SD601A-Q
Q019	8-729-422-27	TRANSISTOR	2SD601A-Q	Q1104	8-729-422-27	TRANSISTOR	2SD601A-Q
Q020	8-729-422-27	TRANSISTOR	2SD601A-Q	Q1105	8-729-027-56	TRANSISTOR	DTC143TKA-T146
Q021	8-729-422-27	TRANSISTOR	2SD601A-Q	Q1106	8-729-422-27	TRANSISTOR	2SD601A-Q
Q022	8-729-422-27	TRANSISTOR	2SD601A-Q	Q1107	8-729-422-27	TRANSISTOR	2SD601A-Q
Q023	8-729-422-27	TRANSISTOR	2SD601A-Q	Q1108	8-729-027-56	TRANSISTOR	DTC143TKA-T146
Q151	1-801-806-11	TRANSISTOR	DTC144EKA-T146	Q1109	8-729-027-56	TRANSISTOR	DTC143TKA-T146
Q152	8-729-422-27	TRANSISTOR	2SD601A-Q	Q1110	8-729-027-56	TRANSISTOR	DTC143TKA-T146
Q153	8-729-422-27	TRANSISTOR	2SD601A-Q	Q1111	8-729-216-22	TRANSISTOR	2SA1162-G
Q154	8-729-216-22	TRANSISTOR	2SA1162-G	Q1112	8-729-216-22	TRANSISTOR	2SA1162-G
Q217	8-729-422-27	TRANSISTOR	2SD601A-Q	Q1113	8-729-422-27	TRANSISTOR	2SD601A-Q
Q218	8-729-216-22	TRANSISTOR	2SA1162-G	Q1114	8-729-216-22	TRANSISTOR	2SA1162-G
Q219	8-729-216-22	TRANSISTOR	2SA1162-G	Q1115	8-729-216-22	TRANSISTOR	2SA1162-G
Q220	8-729-216-22	TRANSISTOR	2SA1162-G	Q1116	8-729-422-27	TRANSISTOR	2SD601A-Q
Q222	8-729-422-27	TRANSISTOR	2SD601A-Q	Q1117	8-729-422-27	TRANSISTOR	2SD601A-Q
Q223	8-729-422-27	TRANSISTOR	2SD601A-Q	Q1118	8-729-422-27	TRANSISTOR	2SD601A-Q
Q226	8-729-422-27	TRANSISTOR	2SD601A-Q	Q1119	8-729-422-27	TRANSISTOR	2SD601A-Q
Q227	8-729-422-27	TRANSISTOR	2SD601A-Q	Q1121	1-801-806-11	TRANSISTOR	DTC144EKA-T146
Q228	8-729-422-27	TRANSISTOR	2SD601A-Q	Q1122	8-729-422-27	TRANSISTOR	2SD601A-Q
Q229	8-729-216-22	TRANSISTOR	2SA1162-G	Q1124	8-729-216-22	TRANSISTOR	2SA1162-G
Q230	8-729-216-22	TRANSISTOR	2SA1162-G	Q1125	8-729-216-22	TRANSISTOR	2SA1162-G
Q231	8-729-216-22	TRANSISTOR	2SA1162-G	Q1601	8-729-422-27	TRANSISTOR	2SD601A-Q
Q232	8-729-216-22	TRANSISTOR	2SA1162-G	Q1602	8-729-422-27	TRANSISTOR	2SD601A-Q
Q301	8-729-216-22	TRANSISTOR	2SA1162-G	Q1603	8-729-422-27	TRANSISTOR	2SD601A-Q
Q302	8-729-422-27	TRANSISTOR	2SD601A-Q	Q1701	8-729-422-27	TRANSISTOR	2SD601A-Q
				Q1702	8-729-422-27	TRANSISTOR	2SD601A-Q
				Q1703	8-729-422-27	TRANSISTOR	2SD601A-Q
				Q1704	8-729-216-22	TRANSISTOR	2SA1162-G
				Q1705	8-729-216-22	TRANSISTOR	2SA1162-G



REF. NO.	PART NO.	DESCRIPTION	REMARK	REF. NO.	PART NO.	DESCRIPTION	REMARK
Q1706	8-729-422-27	TRANSISTOR 2SD601A-Q		R034	1-216-033-00	RES,CHIP 220	5% 1/10W
Q1707	8-729-422-27	TRANSISTOR 2SD601A-Q		R035	1-216-033-00	RES,CHIP 220	5% 1/10W
Q1708	8-729-216-22	TRANSISTOR 2SA1162-G		R037	1-216-057-00	RES,CHIP 2.2K	5% 1/10W
Q1709	8-729-216-22	TRANSISTOR 2SA1162-G		R038	1-216-089-91	RES,CHIP 47K	5% 1/10W
Q1903	8-729-216-22	TRANSISTOR 2SA1162-G		R040	1-216-057-00	RES,CHIP 2.2K	5% 1/10W
Q1904	8-729-422-27	TRANSISTOR 2SD601A-Q		R041	1-216-033-00	RES,CHIP 220	5% 1/10W
Q1905	8-729-216-22	TRANSISTOR 2SA1162-G		R042	1-216-033-00	RES,CHIP 220	5% 1/10W
Q1906	8-729-422-27	TRANSISTOR 2SD601A-Q		R043	1-216-057-00	RES,CHIP 2.2K	5% 1/10W
Q1907	8-729-216-22	TRANSISTOR 2SA1162-G		R044	1-216-121-91	RES,CHIP 1M	5% 1/10W
Q1908	8-729-216-22	TRANSISTOR 2SA1162-G		R045	1-216-097-91	RES,CHIP 100K	5% 1/10W
Q1909	8-729-422-27	TRANSISTOR 2SD601A-Q		R046	1-216-073-00	RES,CHIP 10K	5% 1/10W
Q1910	8-729-216-22	TRANSISTOR 2SA1162-G		R047	1-216-073-00	RES,CHIP 10K	5% 1/10W
Q1911	8-729-422-27	TRANSISTOR 2SD601A-Q		R048	1-216-065-91	RES,CHIP 4.7K	5% 1/10W
Q1913	8-729-422-27	TRANSISTOR 2SD601A-Q		R049	1-216-049-91	RES,CHIP 1K	5% 1/10W
Q1914	8-729-216-22	TRANSISTOR 2SA1162-G		R050	1-216-049-91	RES,CHIP 1K	5% 1/10W
Q1915	8-729-422-27	TRANSISTOR 2SD601A-Q		R051	1-216-049-91	RES,CHIP 1K	5% 1/10W
Q1916	8-729-422-27	TRANSISTOR 2SD601A-Q		R052	1-216-049-91	RES,CHIP 1K	5% 1/10W
Q1917	8-729-422-27	TRANSISTOR 2SD601A-Q		R053	1-216-049-91	RES,CHIP 1K	5% 1/10W
Q1918	8-729-422-27	TRANSISTOR 2SD601A-Q		R054	1-216-033-00	RES,CHIP 220	5% 1/10W
Q1920	8-729-422-27	TRANSISTOR 2SD601A-Q		R055	1-216-033-00	RES,CHIP 220	5% 1/10W
Q1921	8-729-422-27	TRANSISTOR 2SD601A-Q		R056	1-216-049-91	RES,CHIP 1K	5% 1/10W
		<RESISTOR>		R057	1-216-049-91	RES,CHIP 1K	5% 1/10W
R001	1-216-041-00	RES,CHIP 470	5% 1/10W	R059	1-216-089-91	RES,CHIP 47K	5% 1/10W
R002	1-216-057-00	RES,CHIP 2.2K	5% 1/10W	R060	1-216-049-91	RES,CHIP 1K	5% 1/10W
R003	1-216-049-91	RES,CHIP 1K	5% 1/10W	R061	1-216-041-00	RES,CHIP 470	5% 1/10W
R004	1-216-121-91	RES,CHIP 1M	5% 1/10W	R062	1-216-065-91	RES,CHIP 4.7K	5% 1/10W
R005	1-216-097-91	RES,CHIP 100K	5% 1/10W	R063	1-216-065-91	RES,CHIP 4.7K	5% 1/10W
R006	1-216-033-00	RES,CHIP 220	5% 1/10W	R064	1-216-065-91	RES,CHIP 4.7K	5% 1/10W
R007	1-216-073-00	RES,CHIP 10K	5% 1/10W	R066	1-216-065-91	RES,CHIP 4.7K	5% 1/10W
R008	1-216-033-00	RES,CHIP 220	5% 1/10W	R068	1-216-065-91	RES,CHIP 4.7K	5% 1/10W
R009	1-216-033-00	RES,CHIP 220	5% 1/10W	R070	1-216-033-00	RES,CHIP 220	5% 1/10W
R010	1-216-073-00	RES,CHIP 10K	5% 1/10W	R071	1-216-033-00	RES,CHIP 220	5% 1/10W
R011	1-216-049-91	RES,CHIP 1K	5% 1/10W	R072	1-216-065-91	RES,CHIP 4.7K	5% 1/10W
R012	1-216-033-00	RES,CHIP 220	5% 1/10W	R073	1-216-295-00	SHORT 0	
R013	1-216-073-00	RES,CHIP 10K	5% 1/10W	R074	1-216-065-91	RES,CHIP 4.7K	5% 1/10W
R014	1-216-065-91	RES,CHIP 4.7K	5% 1/10W	R075	1-216-061-00	RES,CHIP 3.3K	5% 1/10W
R016	1-216-033-00	RES,CHIP 220	5% 1/10W	R076	1-216-037-00	RES,CHIP 330	5% 1/10W
R017	1-216-033-00	RES,CHIP 220	5% 1/10W	R077	1-216-053-00	RES,CHIP 1.5K	5% 1/10W
R018	1-216-033-00	RES,CHIP 220	5% 1/10W	R078	1-216-025-91	RES,CHIP 100	5% 1/10W
R019	1-216-033-00	RES,CHIP 220	5% 1/10W	R079	1-216-061-00	RES,CHIP 3.3K	5% 1/10W
R020	1-216-033-00	RES,CHIP 220	5% 1/10W	R084	1-216-025-91	RES,CHIP 100	5% 1/10W
R021	1-216-033-00	RES,CHIP 220	5% 1/10W	R085	1-216-053-00	RES,CHIP 1.5K	5% 1/10W
R022	1-216-033-00	RES,CHIP 220	5% 1/10W	R086	1-216-053-00	RES,CHIP 1.5K	5% 1/10W
R023	1-216-049-91	RES,CHIP 1K	5% 1/10W	R087	1-216-053-00	RES,CHIP 1.5K	5% 1/10W
R024	1-216-025-91	RES,CHIP 100	5% 1/10W	R088	1-216-025-91	RES,CHIP 100	5% 1/10W
R025	1-216-025-91	RES,CHIP 100	5% 1/10W	R089	1-216-055-00	RES,CHIP 1.8K	5% 1/10W
R026	1-216-025-91	RES,CHIP 100	5% 1/10W	R090	1-216-113-00	RES,CHIP 470K	5% 1/10W
R027	1-216-025-91	RES,CHIP 100	5% 1/10W	R091	1-216-017-91	RES,CHIP 47	5% 1/10W
R028	1-216-065-91	RES,CHIP 4.7K	5% 1/10W	R092	1-216-113-00	RES,CHIP 470K	5% 1/10W
R029	1-216-065-91	RES,CHIP 4.7K	5% 1/10W	R093	1-216-017-91	RES,CHIP 47	5% 1/10W
R030	1-216-033-00	RES,CHIP 220	5% 1/10W	R094	1-216-113-00	RES,CHIP 470K	5% 1/10W
R031	1-216-037-00	RES,CHIP 330	5% 1/10W	R095	1-216-017-91	RES,CHIP 47	5% 1/10W
R032	1-216-033-00	RES,CHIP 220	5% 1/10W	R096	1-216-055-00	RES,CHIP 1.8K	5% 1/10W
R033	1-216-033-00	RES,CHIP 220	5% 1/10W	R097	1-216-055-00	RES,CHIP 1.8K	5% 1/10W
				R099	1-216-041-00	RES,CHIP 470	5% 1/10W
				R100	1-216-041-00	RES,CHIP 470	5% 1/10W



REF. NO.	PART NO.	DESCRIPTION	REMARK	REF. NO.	PART NO.	DESCRIPTION	REMARK
R101	1-216-041-00	RES,CHIP	470 5% 1/10W	R279	1-216-129-00	RES,CHIP	2.2M 5% 1/10W
R102	1-216-113-00	RES,CHIP	470K 5% 1/10W	R281	1-216-094-00	RES,CHIP	75K 5% 1/10W
R103	1-216-113-00	RES,CHIP	470K 5% 1/10W	R282	1-216-065-91	RES,CHIP	4.7K 5% 1/10W
R104	1-216-113-00	RES,CHIP	470K 5% 1/10W	R283	1-216-065-91	RES,CHIP	4.7K 5% 1/10W
R105	1-216-017-91	RES,CHIP	47 5% 1/10W	R284	1-216-025-91	RES,CHIP	100 5% 1/10W
R106	1-216-017-91	RES,CHIP	47 5% 1/10W	R285	1-216-049-91	RES,CHIP	1K 5% 1/10W
R107	1-216-017-91	RES,CHIP	47 5% 1/10W	R286	1-216-025-91	RES,CHIP	100 5% 1/10W
R108	1-216-113-00	RES,CHIP	470K 5% 1/10W	R287	1-216-025-91	RES,CHIP	100 5% 1/10W
R109	1-216-113-00	RES,CHIP	470K 5% 1/10W	R288	1-216-295-00	SHORT	0
R110	1-216-043-91	RES,CHIP	560 5% 1/10W	R289	1-216-049-91	RES,CHIP	1K 5% 1/10W
R111	1-216-043-91	RES,CHIP	560 5% 1/10W	R290	1-216-049-91	RES,CHIP	1K 5% 1/10W
R112	1-216-043-91	RES,CHIP	560 5% 1/10W	R291	1-216-049-91	RES,CHIP	1K 5% 1/10W
R113	1-216-113-00	RES,CHIP	470K 5% 1/10W	R292	1-216-049-91	RES,CHIP	1K 5% 1/10W
R114	1-216-045-00	RES,CHIP	680 5% 1/10W	R293	1-216-049-91	RES,CHIP	1K 5% 1/10W
R115	1-216-045-00	RES,CHIP	680 5% 1/10W	R294	1-216-049-91	RES,CHIP	1K 5% 1/10W
R116	1-216-045-00	RES,CHIP	680 5% 1/10W	R295	1-216-295-00	SHORT	0
R117	1-216-295-00	SHORT	0	R296	1-216-033-00	RES,CHIP	220 5% 1/10W
R118	1-216-053-00	RES,CHIP	1.5K 5% 1/10W	R297	1-216-295-00	SHORT	0
R119	1-216-053-00	RES,CHIP	1.5K 5% 1/10W	R299	1-216-049-91	RES,CHIP	1K 5% 1/10W
R120	1-216-033-00	RES,CHIP	220 5% 1/10W	R300	1-216-049-91	RES,CHIP	1K 5% 1/10W
R121	1-216-057-00	RES,CHIP	2.2K 5% 1/10W	R301	1-216-033-00	RES,CHIP	220 5% 1/10W
R122	1-216-025-91	RES,CHIP	100 5% 1/10W	R302	1-216-049-91	RES,CHIP	1K 5% 1/10W
R123	1-216-017-91	RES,CHIP	47 5% 1/10W	R303	1-216-075-00	RES,CHIP	12K 5% 1/10W
R124	1-216-017-91	RES,CHIP	47 5% 1/10W	R304	1-216-045-00	RES,CHIP	680 5% 1/10W
R125	1-216-017-91	RES,CHIP	47 5% 1/10W	R305	1-216-025-91	RES,CHIP	100 5% 1/10W
R132	1-216-065-91	RES,CHIP	4.7K 5% 1/10W	R307	1-208-806-11	METAL CHIP	10K 0.5% 1/10W
R135	1-216-295-00	SHORT	0	R310	1-216-033-00	RES,CHIP	220 5% 1/10W
R151	1-216-025-91	RES,CHIP	100 5% 1/10W	R311	1-216-025-91	RES,CHIP	100 5% 1/10W
R152	1-216-083-00	RES,CHIP	27K 5% 1/10W	R312	1-216-025-91	RES,CHIP	100 5% 1/10W
R153	1-216-689-11	RES,CHIP	39K 5% 1/10W	R313	1-216-073-00	RES,CHIP	10K 5% 1/10W
R154	1-216-043-91	RES,CHIP	560 5% 1/10W	R316	1-216-049-91	RES,CHIP	1K 5% 1/10W
R155	1-216-025-91	RES,CHIP	100 5% 1/10W	R318	1-216-073-00	RES,CHIP	10K 5% 1/10W
R156	1-216-045-00	RES,CHIP	680 5% 1/10W	R320	1-216-073-00	RES,CHIP	10K 5% 1/10W
R157	1-216-049-91	RES,CHIP	1K 5% 1/10W	R321	1-216-033-00	RES,CHIP	220 5% 1/10W
R158	1-216-464-11	METAL OXIDE	18K 5% 2W	R322	1-216-073-00	RES,CHIP	10K 5% 1/10W
R159	1-216-041-00	RES,CHIP	470 5% 1/10W	R323	1-216-017-91	RES,CHIP	47 5% 1/10W
R160	1-216-025-91	RES,CHIP	100 5% 1/10W	R324	1-216-061-00	RES,CHIP	3.3K 5% 1/10W
R161	1-216-083-00	RES,CHIP	27K 5% 1/10W	R325	1-216-061-00	RES,CHIP	3.3K 5% 1/10W
R162	1-216-041-00	RES,CHIP	470 5% 1/10W	R326	1-216-049-91	RES,CHIP	1K 5% 1/10W
R163	1-216-689-11	RES,CHIP	39K 5% 1/10W	R335	1-216-041-00	RES,CHIP	470 5% 1/10W
R164	1-216-065-91	RES,CHIP	4.7K 5% 1/10W	R336	1-216-049-91	RES,CHIP	1K 5% 1/10W
R166	1-216-025-91	RES,CHIP	100 5% 1/10W	R337	1-216-049-91	RES,CHIP	1K 5% 1/10W
R167	1-216-025-91	RES,CHIP	100 5% 1/10W	R338	1-216-077-91	RES,CHIP	15K 5% 1/10W
R168	1-216-025-91	RES,CHIP	100 5% 1/10W	R339	1-216-049-91	RES,CHIP	1K 5% 1/10W
R169	1-208-789-11	METAL CHIP	2K 0.5% 1/10W	R340	1-216-041-00	RES,CHIP	470 5% 1/10W
R170	1-216-025-91	RES,CHIP	100 5% 1/10W	R342	1-216-049-91	RES,CHIP	1K 5% 1/10W
R171	1-216-295-00	SHORT	0	R343	1-216-081-00	RES,CHIP	22K 5% 1/10W
R203	1-216-059-00	RES,CHIP	2.7K 5% 1/10W	R344	1-216-025-91	RES,CHIP	100 5% 1/10W
R204	1-216-041-00	RES,CHIP	470 5% 1/10W	R345	1-216-049-91	RES,CHIP	1K 5% 1/10W
R207	1-216-041-00	RES,CHIP	470 5% 1/10W	R347	1-216-073-00	RES,CHIP	10K 5% 1/10W
R208	1-216-295-00	SHORT	0	R348	1-216-079-00	RES,CHIP	18K 5% 1/10W
R274	1-216-073-00	RES,CHIP	10K 5% 1/10W	R349	1-216-077-91	RES,CHIP	15K 5% 1/10W
R275	1-216-057-00	RES,CHIP	2.2K 5% 1/10W	R350	1-216-073-00	RES,CHIP	10K 5% 1/10W
R276	1-216-097-91	RES,CHIP	100K 5% 1/10W	R351	1-216-041-00	RES,CHIP	470 5% 1/10W
R277	1-216-089-91	RES,CHIP	47K 5% 1/10W	R352	1-216-081-00	RES,CHIP	22K 5% 1/10W
R278	1-216-073-00	RES,CHIP	10K 5% 1/10W	R356	1-216-061-00	RES,CHIP	3.3K 5% 1/10W



REF. NO.	PART NO.	DESCRIPTION		REMARK	REF. NO.	PART NO.	DESCRIPTION		REMARK
R357	1-216-041-00	RES,CHIP	470	5% 1/10W	R810	1-216-295-00	SHORT	0	
R361	1-208-803-11	METAL CHIP	7.5K	0.5% 1/10W	R811	1-216-109-00	RES,CHIP	330K	5% 1/10W
R362	1-208-774-11	METAL CHIP	470	0.5% 1/10W	R813	1-216-117-00	RES,CHIP	680K	5% 1/10W
R363	1-208-798-11	METAL CHIP	4.7K	0.5% 1/10W	R814	1-216-117-00	RES,CHIP	680K	5% 1/10W
R411	1-216-025-91	RES,CHIP	100	5% 1/10W					
R412	1-216-025-91	RES,CHIP	100	5% 1/10W	R815	1-216-025-91	RES,CHIP	100	5% 1/10W
R413	1-216-025-91	RES,CHIP	100	5% 1/10W	R816	1-216-049-91	RES,CHIP	1K	5% 1/10W
R414	1-216-081-00	RES,CHIP	22K	5% 1/10W	R817	1-216-025-91	RES,CHIP	100	5% 1/10W
R415	1-216-073-00	RES,CHIP	10K	5% 1/10W	R818	1-216-025-91	RES,CHIP	100	5% 1/10W
R418	1-216-025-91	RES,CHIP	100	5% 1/10W	R819	1-216-025-91	RES,CHIP	100	5% 1/10W
R419	1-216-025-91	RES,CHIP	100	5% 1/10W	R820	1-216-295-00	SHORT	0	
R420	1-216-025-91	RES,CHIP	100	5% 1/10W	R821	1-216-295-00	SHORT	0	
R421	1-216-025-91	RES,CHIP	100	5% 1/10W	R822	1-216-295-00	SHORT	0	
R422	1-216-025-91	RES,CHIP	100	5% 1/10W	R823	1-216-295-00	SHORT	0	
R423	1-216-089-91	RES,CHIP	47K	5% 1/10W	R824	1-216-025-91	RES,CHIP	100	5% 1/10W
R425	1-216-025-91	RES,CHIP	100	5% 1/10W	R825	1-216-025-91	RES,CHIP	100	5% 1/10W
R426	1-216-073-00	RES,CHIP	10K	5% 1/10W	R828	1-216-049-91	RES,CHIP	1K	5% 1/10W
R428	1-216-073-00	RES,CHIP	10K	5% 1/10W	R829	1-216-073-00	RES,CHIP	10K	5% 1/10W
R429	1-216-073-00	RES,CHIP	10K	5% 1/10W	R830	1-216-041-00	RES,CHIP	470	5% 1/10W
R430	1-216-041-00	RES,CHIP	470	5% 1/10W	R831	1-216-049-91	RES,CHIP	1K	5% 1/10W
R431	1-216-073-00	RES,CHIP	10K	5% 1/10W	R832	1-216-073-00	RES,CHIP	10K	5% 1/10W
R432	1-216-041-00	RES,CHIP	470	5% 1/10W	R833	1-216-049-91	RES,CHIP	1K	5% 1/10W
R433	1-216-041-00	RES,CHIP	470	5% 1/10W	R834	1-216-049-91	RES,CHIP	1K	5% 1/10W
R434	1-216-097-91	RES,CHIP	100K	5% 1/10W	R836	1-216-049-91	RES,CHIP	1K	5% 1/10W
R435	1-216-073-00	RES,CHIP	10K	5% 1/10W	R838	1-216-025-91	RES,CHIP	100	5% 1/10W
R436	1-216-079-00	RES,CHIP	18K	5% 1/10W	R839	1-216-025-91	RES,CHIP	100	5% 1/10W
R437	1-216-047-91	RES,CHIP	820	5% 1/10W	R840	1-216-025-91	RES,CHIP	100	5% 1/10W
R438	1-216-073-00	RES,CHIP	10K	5% 1/10W	R842	1-216-025-91	RES,CHIP	100	5% 1/10W
R440	1-216-047-91	RES,CHIP	820	5% 1/10W	R843	1-216-025-91	RES,CHIP	100	5% 1/10W
R441	1-216-049-91	RES,CHIP	1K	5% 1/10W	R844	1-216-025-91	RES,CHIP	100	5% 1/10W
R442	1-216-041-00	RES,CHIP	470	5% 1/10W	R846	1-216-025-91	RES,CHIP	100	5% 1/10W
R443	1-216-073-00	RES,CHIP	10K	5% 1/10W	R847	1-216-033-00	RES,CHIP	220	5% 1/10W
R444	1-216-077-91	RES,CHIP	15K	5% 1/10W	R848	1-216-025-91	RES,CHIP	100	5% 1/10W
R445	1-216-079-00	RES,CHIP	18K	5% 1/10W	R849	1-216-041-00	RES,CHIP	470	5% 1/10W
R446	1-216-085-00	RES,CHIP	33K	5% 1/10W	R850	1-216-041-00	RES,CHIP	470	5% 1/10W
R447	1-216-079-00	RES,CHIP	18K	5% 1/10W	R851	1-216-041-00	RES,CHIP	470	5% 1/10W
R448	1-216-079-00	RES,CHIP	18K	5% 1/10W	R852	1-208-814-91	METAL CHIP	22K	0.5% 1/10W
R449	1-216-049-91	RES,CHIP	1K	5% 1/10W	R853	1-216-025-91	RES,CHIP	100	5% 1/10W
R451	1-216-073-00	RES,CHIP	10K	5% 1/10W	R854	1-216-025-91	RES,CHIP	100	5% 1/10W
R452	1-216-083-00	RES,CHIP	27K	5% 1/10W	R855	1-216-025-91	RES,CHIP	100	5% 1/10W
R455	1-216-083-00	RES,CHIP	27K	5% 1/10W	R856	1-216-033-00	RES,CHIP	220	5% 1/10W
R458	1-249-389-11	CARBON	4.7	5% 1/4W F	R857	1-216-025-91	RES,CHIP	100	5% 1/10W
R459	1-249-389-11	CARBON	4.7	5% 1/4W F	R858	1-216-073-00	RES,CHIP	10K	5% 1/10W
R460	1-216-089-91	RES,CHIP	47K	5% 1/10W	R859	1-216-081-00	RES,CHIP	22K	5% 1/10W
R461	1-216-025-91	RES,CHIP	100	5% 1/10W	R860	1-216-025-91	RES,CHIP	100	5% 1/10W
R462	1-216-075-00	RES,CHIP	12K	5% 1/10W	R861	1-216-073-00	RES,CHIP	10K	5% 1/10W
R463	1-216-089-91	RES,CHIP	47K	5% 1/10W	R862	1-216-073-00	RES,CHIP	10K	5% 1/10W
R464	1-216-089-91	RES,CHIP	47K	5% 1/10W	R863	1-216-025-91	RES,CHIP	100	5% 1/10W
R465	1-216-121-91	RES,CHIP	1M	5% 1/10W	R864	1-208-801-11	METAL CHIP	6.2K	0.5% 1/10W
R466	1-216-079-00	RES,CHIP	18K	5% 1/10W	R865	1-216-025-91	RES,CHIP	100	5% 1/10W
R467	1-216-077-91	RES,CHIP	15K	5% 1/10W	R866	1-216-025-91	RES,CHIP	100	5% 1/10W
R468	1-216-295-00	SHORT	0		R867	1-216-025-91	RES,CHIP	100	5% 1/10W
R474	1-216-049-91	RES,CHIP	1K	5% 1/10W	R868	1-216-025-91	RES,CHIP	100	5% 1/10W
R805	1-216-065-91	RES,CHIP	4.7K	5% 1/10W	R869	1-216-025-91	RES,CHIP	100	5% 1/10W
R806	1-216-113-00	RES,CHIP	470K	5% 1/10W	R870	1-216-073-00	RES,CHIP	10K	5% 1/10W
R808	1-216-065-91	RES,CHIP	4.7K	5% 1/10W	R871	1-216-025-91	RES,CHIP	100	5% 1/10W
					R872	1-216-025-91	RES,CHIP	100	5% 1/10W



REF. NO.	PART NO.	DESCRIPTION		REMARK	REF. NO.	PART NO.	DESCRIPTION		REMARK
R873	1-216-025-91	RES,CHIP	100	5% 1/10W	R941	1-216-061-00	RES,CHIP	3.3K	5% 1/10W
R874	1-216-025-91	RES,CHIP	100	5% 1/10W	R942	1-216-065-91	RES,CHIP	4.7K	5% 1/10W
R875	1-216-295-00	SHORT	0						
R876	1-216-065-91	RES,CHIP	4.7K	5% 1/10W	R943	1-216-041-00	RES,CHIP	470	5% 1/10W
R877	1-208-816-11	METAL CHIP	27K	0.5% 1/10W	R945	1-216-069-00	RES,CHIP	6.8K	5% 1/10W
R878	1-216-049-91	RES,CHIP	1K	5% 1/10W	R950	1-216-043-91	RES,CHIP	560	5% 1/10W
R879	1-216-295-00	SHORT	0		R951	1-216-053-00	RES,CHIP	1.5K	5% 1/10W
R880	1-216-049-91	RES,CHIP	1K	5% 1/10W	R952	1-216-049-91	RES,CHIP	1K	5% 1/10W
R881	1-216-025-91	RES,CHIP	100	5% 1/10W	R953	1-216-025-91	RES,CHIP	100	5% 1/10W
R882	1-216-033-00	RES,CHIP	220	5% 1/10W	R954	1-216-025-91	RES,CHIP	100	5% 1/10W
R883	1-216-033-00	RES,CHIP	220	5% 1/10W	R955	1-216-025-91	RES,CHIP	100	5% 1/10W
R884	1-216-049-91	RES,CHIP	1K	5% 1/10W	R956	1-216-025-91	RES,CHIP	100	5% 1/10W
R885	1-216-025-91	RES,CHIP	100	5% 1/10W	R957	1-216-025-91	RES,CHIP	100	5% 1/10W
R888	1-216-025-91	RES,CHIP	100	5% 1/10W	R958	1-216-025-91	RES,CHIP	100	5% 1/10W
R891	1-216-073-00	RES,CHIP	10K	5% 1/10W	R959	1-208-806-11	METAL CHIP	10K	0.5% 1/10W
R892	1-208-802-11	METAL CHIP	6.8K	0.5% 1/10W	R960	1-208-806-11	METAL CHIP	10K	0.5% 1/10W
R893	1-216-073-00	RES,CHIP	10K	5% 1/10W	R961	1-208-806-11	METAL CHIP	10K	0.5% 1/10W
R894	1-216-033-00	RES,CHIP	220	5% 1/10W	R962	1-208-806-11	METAL CHIP	10K	0.5% 1/10W
R895	1-216-025-91	RES,CHIP	100	5% 1/10W	R963	1-208-806-11	METAL CHIP	10K	0.5% 1/10W
R896	1-216-121-91	RES,CHIP	1M	5% 1/10W	R964	1-208-806-11	METAL CHIP	10K	0.5% 1/10W
R897	1-216-049-91	RES,CHIP	1K	5% 1/10W	R965	1-208-806-11	METAL CHIP	10K	0.5% 1/10W
R898	1-216-049-91	RES,CHIP	1K	5% 1/10W	R966	1-208-806-11	METAL CHIP	10K	0.5% 1/10W
R899	1-216-033-00	RES,CHIP	220	5% 1/10W	R968	1-208-806-11	METAL CHIP	10K	0.5% 1/10W
R900	1-216-025-91	RES,CHIP	100	5% 1/10W	R970	1-208-806-11	METAL CHIP	10K	0.5% 1/10W
R901	1-216-033-00	RES,CHIP	220	5% 1/10W	R972	1-208-806-11	METAL CHIP	10K	0.5% 1/10W
R902	1-216-033-00	RES,CHIP	220	5% 1/10W	R974	1-208-806-11	METAL CHIP	10K	0.5% 1/10W
R903	1-216-025-91	RES,CHIP	100	5% 1/10W	R976	1-208-806-11	METAL CHIP	10K	0.5% 1/10W
R904	1-216-033-00	RES,CHIP	220	5% 1/10W	R978	1-208-810-11	METAL CHIP	15K	0.5% 1/10W
R905	1-216-025-91	RES,CHIP	100	5% 1/10W	R979	1-208-817-11	METAL CHIP	30K	0.5% 1/10W
R906	1-216-025-91	RES,CHIP	100	5% 1/10W	R980	1-208-817-11	METAL CHIP	30K	0.5% 1/10W
R907	1-216-025-91	RES,CHIP	100	5% 1/10W	R981	1-208-817-11	METAL CHIP	30K	0.5% 1/10W
R908	1-216-025-91	RES,CHIP	100	5% 1/10W	R982	1-208-817-11	METAL CHIP	30K	0.5% 1/10W
R910	1-216-025-91	RES,CHIP	100	5% 1/10W	R983	1-208-817-11	METAL CHIP	30K	0.5% 1/10W
R911	1-216-025-91	RES,CHIP	100	5% 1/10W	R985	1-208-810-11	METAL CHIP	15K	0.5% 1/10W
R912	1-216-049-91	RES,CHIP	1K	5% 1/10W	R987	1-208-817-11	METAL CHIP	30K	0.5% 1/10W
R913	1-216-025-91	RES,CHIP	100	5% 1/10W	R989	1-208-817-11	METAL CHIP	30K	0.5% 1/10W
R914	1-216-049-91	RES,CHIP	1K	5% 1/10W	R991	1-208-817-11	METAL CHIP	30K	0.5% 1/10W
R915	1-216-049-91	RES,CHIP	1K	5% 1/10W	R993	1-208-817-11	METAL CHIP	30K	0.5% 1/10W
R916	1-216-049-91	RES,CHIP	1K	5% 1/10W	R994	1-208-817-11	METAL CHIP	30K	0.5% 1/10W
R917	1-216-025-91	RES,CHIP	100	5% 1/10W	R996	1-208-776-11	METAL CHIP	560	0.5% 1/10W
R918	1-208-806-11	METAL CHIP	10K	0.5% 1/10W	R997	1-208-776-11	METAL CHIP	560	0.5% 1/10W
R919	1-216-061-00	RES,CHIP	3.3K	5% 1/10W	R998	1-208-776-11	METAL CHIP	560	0.5% 1/10W
R920	1-216-061-00	RES,CHIP	3.3K	5% 1/10W	R999	1-208-776-11	METAL CHIP	560	0.5% 1/10W
R922	1-216-049-91	RES,CHIP	1K	5% 1/10W	R1000	1-208-776-11	METAL CHIP	560	0.5% 1/10W
R923	1-216-043-91	RES,CHIP	560	5% 1/10W	R1001	1-208-776-11	METAL CHIP	560	0.5% 1/10W
R924	1-216-053-00	RES,CHIP	1.5K	5% 1/10W	R1002	1-208-810-11	METAL CHIP	15K	0.5% 1/10W
R925	1-216-043-91	RES,CHIP	560	5% 1/10W	R1003	1-208-818-11	METAL CHIP	33K	0.5% 1/10W
R926	1-216-053-00	RES,CHIP	1.5K	5% 1/10W	R1010	1-216-295-00	SHORT	0	
R928	1-216-057-00	RES,CHIP	2.2K	5% 1/10W	R1011	1-216-295-00	SHORT	0	
R929	1-216-049-91	RES,CHIP	1K	5% 1/10W	R1012	1-216-295-00	SHORT	0	
R932	1-208-792-11	METAL CHIP	2.7K	0.5% 1/10W	R1013	1-216-295-00	SHORT	0	
R935	1-216-025-91	RES,CHIP	100	5% 1/10W	R1014	1-216-295-00	SHORT	0	
R936	1-216-025-91	RES,CHIP	100	5% 1/10W	R1015	1-216-295-00	SHORT	0	
R937	1-216-025-91	RES,CHIP	100	5% 1/10W	R1101	1-216-041-00	RES,CHIP	470	5% 1/10W
R938	1-208-766-11	METAL CHIP	220	0.5% 1/10W	R1102	1-216-041-00	RES,CHIP	470	5% 1/10W
R939	1-208-766-11	METAL CHIP	220	0.5% 1/10W	R1103	1-216-022-00	RES,CHIP	75	5% 1/10W
					R1106	1-216-041-00	RES,CHIP	470	5% 1/10W



REF. NO.	PART NO.	DESCRIPTION	REMARK	REF. NO.	PART NO.	DESCRIPTION	REMARK
R1107	1-216-041-00	RES,CHIP	470 5% 1/10W	R1173	1-216-049-91	RES,CHIP	1K 5% 1/10W
R1108	1-216-113-00	RES,CHIP	470K 5% 1/10W	R1174	1-208-774-11	METAL CHIP	470 0.5% 1/10W
R1109	1-216-113-00	RES,CHIP	470K 5% 1/10W	R1175	1-208-774-11	METAL CHIP	470 0.5% 1/10W
R1110	1-216-089-91	RES,CHIP	47K 5% 1/10W	R1180	1-216-089-91	RES,CHIP	47K 5% 1/10W
R1111	1-216-025-91	RES,CHIP	100 5% 1/10W	R1182	1-216-049-91	RES,CHIP	1K 5% 1/10W
R1112	1-216-022-00	RES,CHIP	75 5% 1/10W	R1183	1-216-648-11	METAL CHIP	750 0.5% 1/10W
R1113	1-216-022-00	RES,CHIP	75 5% 1/10W	R1184	1-216-648-11	METAL CHIP	750 0.5% 1/10W
R1114	1-216-022-00	RES,CHIP	75 5% 1/10W	R1187	1-216-025-91	RES,CHIP	100 5% 1/10W
R1115	1-216-113-00	RES,CHIP	470K 5% 1/10W	R1188	1-216-025-91	RES,CHIP	100 5% 1/10W
R1116	1-216-113-00	RES,CHIP	470K 5% 1/10W	R1191	1-216-025-91	RES,CHIP	100 5% 1/10W
R1117	1-216-022-00	RES,CHIP	75 5% 1/10W	R1193	1-216-041-00	RES,CHIP	470 5% 1/10W
R1118	1-216-022-00	RES,CHIP	75 5% 1/10W	R1197	1-216-041-00	RES,CHIP	470 5% 1/10W
R1119	1-216-022-00	RES,CHIP	75 5% 1/10W	R1202	1-216-025-91	RES,CHIP	100 5% 1/10W
R1120	1-216-113-00	RES,CHIP	470K 5% 1/10W	R1203	1-216-065-91	RES,CHIP	4.7K 5% 1/10W
R1121	1-216-113-00	RES,CHIP	470K 5% 1/10W	R1204	1-216-025-91	RES,CHIP	100 5% 1/10W
R1122	1-216-022-00	RES,CHIP	75 5% 1/10W	R1205	1-216-065-91	RES,CHIP	4.7K 5% 1/10W
R1123	1-216-022-00	RES,CHIP	75 5% 1/10W	R1206	1-216-025-91	RES,CHIP	100 5% 1/10W
R1124	1-216-022-00	RES,CHIP	75 5% 1/10W	R1207	1-216-049-91	RES,CHIP	1K 5% 1/10W
R1126	1-216-113-00	RES,CHIP	470K 5% 1/10W	R1208	1-216-025-91	RES,CHIP	100 5% 1/10W
R1127	1-216-113-00	RES,CHIP	470K 5% 1/10W	R1209	1-216-065-91	RES,CHIP	4.7K 5% 1/10W
R1128	1-216-019-00	RES,CHIP	56 5% 1/10W	R1210	1-216-025-91	RES,CHIP	100 5% 1/10W
R1129	1-216-017-91	RES,CHIP	47 5% 1/10W	R1211	1-216-065-91	RES,CHIP	4.7K 5% 1/10W
R1130	1-216-025-91	RES,CHIP	100 5% 1/10W	R1212	1-216-025-91	RES,CHIP	100 5% 1/10W
R1131	1-216-057-00	RES,CHIP	2.2K 5% 1/10W	R1213	1-216-025-91	RES,CHIP	100 5% 1/10W
R1132	1-216-073-00	RES,CHIP	10K 5% 1/10W	R1214	1-216-025-91	RES,CHIP	100 5% 1/10W
R1135	1-216-041-00	RES,CHIP	470 5% 1/10W	R1215	1-216-025-91	RES,CHIP	100 5% 1/10W
R1136	1-216-041-00	RES,CHIP	470 5% 1/10W	R1216	1-216-025-91	RES,CHIP	100 5% 1/10W
R1137	1-216-073-00	RES,CHIP	10K 5% 1/10W	R1217	1-216-025-91	RES,CHIP	100 5% 1/10W
R1138	1-216-089-91	RES,CHIP	47K 5% 1/10W	R1218	1-216-025-91	RES,CHIP	100 5% 1/10W
R1139	1-216-041-00	RES,CHIP	470 5% 1/10W	R1221	1-216-025-91	RES,CHIP	100 5% 1/10W
R1140	1-216-065-91	RES,CHIP	4.7K 5% 1/10W	R1222	1-216-025-91	RES,CHIP	100 5% 1/10W
R1141	1-216-073-00	RES,CHIP	10K 5% 1/10W	R1223	1-216-025-91	RES,CHIP	100 5% 1/10W
R1142	1-216-089-91	RES,CHIP	47K 5% 1/10W	R1601	1-216-065-91	RES,CHIP	4.7K 5% 1/10W
R1143	1-216-049-91	RES,CHIP	1K 5% 1/10W	R1603	1-216-033-00	RES,CHIP	220 5% 1/10W
R1144	1-216-057-00	RES,CHIP	2.2K 5% 1/10W	R1605	1-208-802-11	METAL CHIP	6.8K 0.5% 1/10W
R1147	1-216-041-00	RES,CHIP	470 5% 1/10W	R1607	1-208-806-11	METAL CHIP	10K 0.5% 1/10W
R1148	1-216-041-00	RES,CHIP	470 5% 1/10W	R1609	1-216-025-91	RES,CHIP	100 5% 1/10W
R1150	1-216-049-91	RES,CHIP	1K 5% 1/10W	R1610	1-216-025-91	RES,CHIP	100 5% 1/10W
R1151	1-216-105-91	RES,CHIP	220K 5% 1/10W	R1614	1-216-049-91	RES,CHIP	1K 5% 1/10W
R1156	1-216-025-91	RES,CHIP	100 5% 1/10W	R1616	1-216-049-91	RES,CHIP	1K 5% 1/10W
R1157	1-216-065-91	RES,CHIP	4.7K 5% 1/10W	R1617	1-216-081-00	RES,CHIP	22K 5% 1/10W
R1158	1-216-025-91	RES,CHIP	100 5% 1/10W	R1619	1-216-057-00	RES,CHIP	2.2K 5% 1/10W
R1159	1-216-065-91	RES,CHIP	4.7K 5% 1/10W	R1627	1-216-061-00	RES,CHIP	3.3K 5% 1/10W
R1160	1-216-025-91	RES,CHIP	100 5% 1/10W	R1702	1-216-047-91	RES,CHIP	820 5% 1/10W
R1161	1-216-049-91	RES,CHIP	1K 5% 1/10W	R1706	1-216-469-11	METAL OXIDE	12 5% 3W F
R1162	1-216-081-00	RES,CHIP	22K 5% 1/10W	R1707	1-216-049-91	RES,CHIP	1K 5% 1/10W
R1163	1-216-089-91	RES,CHIP	47K 5% 1/10W	R1708	1-208-776-11	METAL CHIP	560 0.5% 1/10W
R1164	1-216-093-91	RES,CHIP	68K 5% 1/10W	R1710	1-216-033-00	RES,CHIP	220 5% 1/10W
R1165	1-216-065-91	RES,CHIP	4.7K 5% 1/10W	R1711	1-216-033-00	RES,CHIP	220 5% 1/10W
R1166	1-216-097-91	RES,CHIP	100K 5% 1/10W	R1712	1-208-800-11	METAL CHIP	5.6K 0.5% 1/10W
R1167	1-216-065-91	RES,CHIP	4.7K 5% 1/10W	R1713	1-216-295-00	SHORT	0
R1168	1-216-081-00	RES,CHIP	22K 5% 1/10W	R1714	1-216-295-00	SHORT	0
R1169	1-216-089-91	RES,CHIP	47K 5% 1/10W	R1721	1-216-635-11	METAL CHIP	220 0.5% 1/10W
R1170	1-216-089-91	RES,CHIP	47K 5% 1/10W	R1722	1-208-769-11	METAL CHIP	300 0.5% 1/10W
R1171	1-216-049-91	RES,CHIP	1K 5% 1/10W	R1724	1-216-041-00	RES,CHIP	470 5% 1/10W
R1172	1-216-065-91	RES,CHIP	4.7K 5% 1/10W				



REF. NO.	PART NO.	DESCRIPTION	REMARK	REF. NO.	PART NO.	DESCRIPTION	REMARK
R1725	1-216-057-00	RES,CHIP	2.2K 5% 1/10W	R1944	1-216-073-00	RES,CHIP	10K 5% 1/10W
R1726	1-216-057-00	RES,CHIP	2.2K 5% 1/10W	R1945	1-216-025-91	RES,CHIP	100 5% 1/10W
R1727	1-208-776-11	METAL CHIP	560 0.5% 1/10W	R1947	1-216-295-00	SHORT	0
R1728	1-208-776-11	METAL CHIP	560 0.5% 1/10W	R1948	1-216-025-91	RES,CHIP	100 5% 1/10W
R1729	1-208-800-11	METAL CHIP	5.6K 0.5% 1/10W	R1949	1-216-025-91	RES,CHIP	100 5% 1/10W
R1730	1-208-800-11	METAL CHIP	5.6K 0.5% 1/10W	R1950	1-216-025-91	RES,CHIP	100 5% 1/10W
R1736	1-216-041-00	RES,CHIP	470 5% 1/10W	R1952	1-216-049-91	RES,CHIP	1K 5% 1/10W
R1738	1-216-041-00	RES,CHIP	470 5% 1/10W	R1953	1-216-025-91	RES,CHIP	100 5% 1/10W
R1739	1-216-049-91	RES,CHIP	1K 5% 1/10W	R1954	1-216-025-91	RES,CHIP	100 5% 1/10W
R1741	1-216-041-00	RES,CHIP	470 5% 1/10W	R1956	1-216-670-11	METAL CHIP	6.2K 0.5% 1/10W
R1742	1-216-049-91	RES,CHIP	1K 5% 1/10W	R1957	1-216-041-91	RES,CHIP	470 5% 1/10W
R1743	1-216-045-00	RES,CHIP	680 5% 1/10W	R1958	1-216-057-00	RES,CHIP	2.2K 5% 1/10W
R1745	1-216-045-00	RES,CHIP	680 5% 1/10W	R1959	1-216-049-91	RES,CHIP	1K 5% 1/10W
R1746	1-216-025-91	RES,CHIP	100 5% 1/10W	R1960	1-208-778-11	METAL CHIP	680 0.5% 1/10W
R1747	1-216-025-91	RES,CHIP	100 5% 1/10W	R1961	1-208-778-11	METAL CHIP	680 0.5% 1/10W
R1749	1-216-053-00	RES,CHIP	1.5K 5% 1/10W	R1962	1-208-778-11	METAL CHIP	680 0.5% 1/10W
R1750	1-216-053-00	RES,CHIP	1.5K 5% 1/10W	R1963	1-216-069-00	RES,CHIP	6.8K 5% 1/10W
R1901	1-216-049-91	RES,CHIP	1K 5% 1/10W	R1964	1-216-037-00	RES,CHIP	330 5% 1/10W
R1905	1-216-065-91	RES,CHIP	4.7K 5% 1/10W	R1965	1-216-025-91	RES,CHIP	100 5% 1/10W
R1906	1-216-065-91	RES,CHIP	4.7K 5% 1/10W	R1966	1-216-041-00	RES,CHIP	470 5% 1/10W
R1907	1-216-049-91	RES,CHIP	1K 5% 1/10W	R1967	1-216-049-91	RES,CHIP	1K 5% 1/10W
R1908	1-216-049-91	RES,CHIP	1K 5% 1/10W	R1968	1-216-049-91	RES,CHIP	1K 5% 1/10W
R1909	1-216-065-91	RES,CHIP	4.7K 5% 1/10W	R1969	1-208-774-11	METAL CHIP	470 0.5% 1/10W
R1910	1-216-061-00	RES,CHIP	3.3K 5% 1/10W	R1970	1-208-780-11	METAL CHIP	820 0.5% 1/10W
R1911	1-216-065-91	RES,CHIP	4.7K 5% 1/10W	R1972	1-216-057-00	RES,CHIP	2.2K 5% 1/10W
R1912	1-216-065-91	RES,CHIP	4.7K 5% 1/10W	R1975	1-216-041-00	RES,CHIP	470 5% 1/10W
R1913	1-216-057-00	RES,CHIP	2.2K 5% 1/10W	R1976	1-208-776-11	METAL CHIP	560 0.5% 1/10W
R1914	1-216-049-91	RES,CHIP	1K 5% 1/10W	R1977	1-216-075-00	RES,CHIP	12K 5% 1/10W
R1915	1-216-033-00	RES,CHIP	220 5% 1/10W	R1978	1-216-081-00	RES,CHIP	22K 5% 1/10W
R1916	1-216-045-00	RES,CHIP	680 5% 1/10W	R1979	1-216-033-00	RES,CHIP	220 5% 1/10W
R1917	1-216-061-00	RES,CHIP	3.3K 5% 1/10W	R1980	1-216-033-00	RES,CHIP	220 5% 1/10W
R1918	1-216-025-91	RES,CHIP	100 5% 1/10W	R1981	1-216-049-91	RES,CHIP	1K 5% 1/10W
R1919	1-216-025-91	RES,CHIP	100 5% 1/10W	R1983	1-208-798-11	METAL CHIP	4.7K 0.5% 1/10W
R1920	1-216-073-00	RES,CHIP	10K 5% 1/10W	R1984	1-216-089-91	RES,CHIP	47K 5% 1/10W
R1921	1-216-109-00	RES,CHIP	330K 5% 1/10W	R1985	1-216-089-91	RES,CHIP	47K 5% 1/10W
R1923	1-216-049-91	RES,CHIP	1K 5% 1/10W	R1986	1-216-097-91	RES,CHIP	100K 5% 1/10W
R1924	1-216-049-91	RES,CHIP	1K 5% 1/10W	R1987	1-216-097-91	RES,CHIP	100K 5% 1/10W
R1925	1-216-049-91	RES,CHIP	1K 5% 1/10W	R1988	1-208-798-11	METAL CHIP	4.7K 0.5% 1/10W
R1926	1-208-778-11	METAL CHIP	680 0.5% 1/10W	R1989	1-216-670-11	METAL CHIP	6.2K 0.5% 1/10W
R1927	1-216-025-91	RES,CHIP	100 5% 1/10W	R1990	1-216-041-00	RES,CHIP	470 5% 1/10W
R1928	1-216-025-91	RES,CHIP	100 5% 1/10W	R5172	1-216-025-91	RES,CHIP	100 5% 1/10W
R1929	1-216-075-00	RES,CHIP	12K 5% 1/10W				
R1930	1-216-295-00	SHORT	0				
R1931	1-216-071-00	RES,CHIP	8.2K 5% 1/10W			<TUNER>	
R1932	1-216-077-91	RES,CHIP	15K 5% 1/10W	TU151	8-598-431-00	TUNER, FSS BTF-WA411	
R1933	1-216-025-91	RES,CHIP	100 5% 1/10W	TU152	8-598-430-00	TUNER, FSS BTF-FA401	
R1934	1-216-049-91	RES,CHIP	1K 5% 1/10W				
R1935	1-208-806-11	METAL CHIP	10K 0.5% 1/10W			<CRYSTAL>	
R1936	1-216-053-00	RES,CHIP	1.5K 5% 1/10W	X001	1-781-589-21	VIBRATOR, CRYSTAL 16MHz	
R1937	1-216-073-00	RES,CHIP	10K 5% 1/10W	X202	1-579-973-11	VIBRATOR, CRYSTAL 3.5756MHz	
R1938	1-216-025-91	RES,CHIP	100 5% 1/10W	X203	1-781-132-21	OSCILLATOR, CRYSTAL 3.5795MHz	
R1939	1-216-025-91	RES,CHIP	100 5% 1/10W	X204	1-579-972-11	VIBRATOR, CRYSTAL 3.582MHz	
R1940	1-216-025-91	RES,CHIP	100 5% 1/10W	X801	1-767-925-21	VIBRATOR, CRYSTAL 12MHz	
R1941	1-216-073-00	RES,CHIP	10K 5% 1/10W	X1901	1-577-611-11	OSCILALTOR, CERAMIC 500kHz	
R1942	1-216-025-91	RES,CHIP	100 5% 1/10W	X1902	1-781-132-21	OSCILLATOR, CRYSTAL 3.5795MHz	
R1943	1-216-053-00	RES,CHIP	1.5K 5% 1/10W				

The components identified by shading and mark Δ are critical for safety.
Replace only with part number specified.

• The components identified by \blacktriangle in this manual have been carefully factory-selected for each set in order to satisfy regulations regarding X-ray radiation. Should replacement be required, replace only with the value originally used.



REF. NO.	PART NO.	DESCRIPTION	REMARK	REF. NO.	PART NO.	DESCRIPTION	REMARK
X1903	1-760-095-21	VIBRATOR, CRYSTAL 20.48MHz		C556	1-104-665-11	ELECT	100μF 20% 25V
X1904	1-579-972-11	VIBRATOR, CRYSTAL 3.582MHz		C557	1-128-562-11	ELECT	47μF 20% 100V
X1905	1-579-973-11	VIBRATOR, CRYSTAL 3.5756mMHz		C563	1-104-664-11	ELECT	47μF 20% 25V
*****				C564	1-102-129-00	CERAMIC	0.01μF 10% 50V
* A-1316-478-A G BOARD, COMPLETE(43T75A)				C565	1-102-129-00	CERAMIC	0.01μF 10% 50V
*****				C566	1-104-666-11	ELECT	220μF 20% 25V
* A-1316-479-A G BOARD, COMPLETE(53SV75A)				C567	1-106-387-00	MYLAR	0.068μF 5% 200V
*****				C619	1-104-664-11	ELECT	47μF 20% 16V
* 4-039-590-01 SHIELD, TRANSFORMER				C625	1-104-664-11	ELECT	47μF 20% 16V
4-382-854-11 SCREW(M3X10), P, SW (+)				C626	1-104-664-11	ELECT	47μF 20% 16V
7-682-952-09 SCREW+PSW 3X16				C651	1-164-644-11	CERAMIC	330pF 10% 500V
<CAPACITOR>				C654	1-126-953-11	ELECT	2200μF 20% 35V
C501	1-126-959-11	ELECT	0.47μF 20% 50V	C655	1-126-953-11	ELECT	2200μF 20% 35V
C502	1-102-002-00	CERAMIC	680pF 10% 500V	C656	1-102-121-00	CERAMIC	0.0022μF 10% 50V
C505	1-106-383-00	MYLAR	0.047μF 10% 200V	C657	1-126-768-11	ELECT	2200μF 20% 16V
C506	1-102-212-00	CERAMIC	820pF 10% 500V	C658	1-126-943-11	ELECT	2200μF 20% 25V
C508	1-102-002-00	CERAMIC	680pF 10% 500V	C659	1-126-943-11	ELECT	2200μF 20% 25V
C510	1-130-471-00	MYLAR	0.001μF 5% 50V	C662	1-123-024-21	ELECT	33μF 160V
C513	1-126-933-11	ELECT	100μF 20% 16V	C663	1-104-665-11	ELECT	100μF 20% 25V
C514	1-130-495-00	MYLAR	0.1μF 5% 50V	C665	1-126-934-11	ELECT	220μF 20% 10V
C515	1-126-960-11	ELECT	1μF 20% 50V	C666	1-126-927-11	ELECT	2200μF 20% 10V
C516	1-126-965-11	ELECT	22μF 20% 50V	C667	1-104-664-11	ELECT	47μF 20% 25V
\blacktriangle C517 Δ		CERAMIC	2KV	C668	1-104-664-11	ELECT	47μF 20% 25V
C518	1-130-487-00	MYLAR	0.022μF 5% 50V	C669	1-104-664-11	ELECT	47μF 20% 25V
C521 Δ	1-128-660-91	FILM	0.039μF 3% 630V	C670	1-137-368-11	MYLAR	0.0047μF 5% 50V
C522 Δ	1-117-658-11	FILM	14000pF 3% 1.2KV	C672	1-104-664-11	ELECT	47μF 20% 25V
C525	1-136-479-11	FILM	0.001μF 5% 50V	C674	1-104-664-11	ELECT	47μF 20% 25V
C526	1-130-475-00	MYLAR	0.0022μF 5% 50V	C676	1-126-940-11	ELECT	330μF 20% 25V
C527	1-129-702-00	FILM	0.001μF 5% 630V	C679	1-104-664-11	ELECT	47μF 20% 25V
C529	1-130-495-00	MYLAR	0.1μF 5% 50V	C1501	1-130-495-00	MYLAR	0.1μF 5% 50V
C531	1-117-673-11	FILM	1.5μF 5% 250V	C1502	1-126-941-11	ELECT	470μF 20% 25V
C533	1-106-359-00	MYLAR	0.0047μF 5% 100V	C1504	1-102-106-00	CERAMIC	100pF 10% 50V
C534	1-162-116-00	CERAMIC	680pF 10% 2KV	C1505	1-104-664-11	ELECT	47μF 20% 25V
C535	1-162-116-00	CERAMIC	680pF 10% 2KV	C1506	1-102-106-00	CERAMIC	100pF 10% 50V
C536	1-126-965-11	ELECT	22μF 20% 50V	C1507	1-126-942-61	ELECT	1000μF 20% 25V
C537	1-102-244-00	CERAMIC	220pF 10% 500V	C1508	1-102-121-00	CERAMIC	0.0022μF 10% 50V
C538	1-106-359-00	MYLAR	0.0047μF 5% 100V	C1510	1-126-941-11	ELECT	470μF 20% 25V
C540	1-107-645-11	ELECT	22μF 20% 160V	C1511	1-126-964-11	ELECT	10μF 20% 50V
C542	1-102-228-00	CERAMIC	470pF 10% 500V	C1512	1-126-933-11	ELECT	100μF 20% 16V
C543	1-117-813-11	FILM	0.75μF 5% 250V	C1513	1-126-964-11	ELECT	10μF 20% 50V
C544	1-110-626-11	ELECT	330μF 20% 160V	C1516	1-104-665-11	ELECT	100μF 20% 25V
C545	1-162-114-00	CERAMIC	0.0047μF 2KV	C1517	1-130-471-00	MYLAR	0.001μF 5% 50V
C546	1-107-649-11	ELECT	2.2μF 20% 250V	C1518	1-102-125-00	CERAMIC	0.0047μF 10% 50V
C547	1-126-971-11	ELECT	470μF 20% 50V	C1519	1-102-106-00	CERAMIC	100pF 10% 50V
C548	1-104-665-11	ELECT	100μF 20% 25V	C1520	1-126-933-11	ELECT	100μF 20% 16V
C549	1-130-489-00	MYLAR	0.033μF 5% 50V	C1521	1-126-941-11	ELECT	470μF 20% 25V
C550	1-104-665-11	ELECT	100μF 20% 25V	C1522	1-126-941-11	ELECT	470μF 20% 25V
C551	1-126-971-11	ELECT	470μF 20% 50V	C1523	1-126-964-11	ELECT	10μF 20% 50V
C552	1-130-489-00	MYLAR	0.033μF 5% 50V	C1524	1-102-106-00	CERAMIC	100pF 10% 50V
C553	1-126-935-11	ELECT	470μF 20% 16V	C1525	1-102-852-91	CERAMIC	47pF 5% 50V
C554	1-126-935-11	ELECT	470μF 20% 16V	C1526	1-136-177-00	MYLAR	1μF 5% 50V
C555	1-104-665-11	ELECT	100μF 20% 25V	C1527	1-102-125-00	CERAMIC	0.0047μF 10% 50V
				C1528	1-126-941-11	ELECT	470μF 20% 25V
				C1530	1-102-106-00	CERAMIC	100pF 10% 50V
				C1531	1-102-106-00	CERAMIC	100pF 10% 50V
				C1533	1-126-941-11	ELECT	470μF 20% 25V



REF. NO.	PART NO.	DESCRIPTION	REMARK	REF. NO.	PART NO.	DESCRIPTION	REMARK
C1534	1-102-125-00	CERAMIC	0.0047µF 10% 50V	C6529	1-126-971-11	ELECT	470µF 20% 50V
C1536	1-102-106-00	CERAMIC	100pF 10% 50V	C6530	1-126-933-11	ELECT	100µF 20% 16V
C1537	1-102-125-00	CERAMIC	0.0047µF 10% 50V	C6532	1-136-165-00	MYLAR	0.1µF 5% 50V
C1538	1-126-941-11	ELECT	470µF 20% 25V	C6539	1-137-605-11	MYLAR	0.01µF 10% 250V
C1539	1-104-665-11	ELECT	100µF 20% 25V	C6540	1-130-467-00	MYLAR	470pF 5% 50V
C1540	1-126-941-11	ELECT	470µF 20% 25V	C6541	1-130-471-00	MYLAR	0.001µF 5% 50V
C1541	1-102-125-00	CERAMIC	0.0047µF 10% 50V	C6542	1-130-467-00	MYLAR	470pF 5% 50V
C1542	1-102-125-00	CERAMIC	0.0047µF 10% 50V	C6543	1-126-965-11	ELECT	22µF 20% 50V
C1543	1-102-129-00	CERAMIC	0.01µF 10% 50V	C6544	1-136-165-00	MYLAR	0.1µF 5% 50V
C1544	1-102-129-00	CERAMIC	0.01µF 10% 50V	C6545	1-130-471-00	MYLAR	0.001µF 5% 50V
C1545	1-126-933-11	ELECT	100µF 20% 16V	<CONNECTOR>			
C1546	1-102-125-00	CERAMIC	0.0047µF 10% 50V	CN501	* 1-779-890-11	CONNECTOR, BOARD TO BOARD	10P
C1547	1-130-487-00	MYLAR	0.022µF 5% 50V	CN502	* 1-506-371-00	PIN, CONNECTOR	2P
C1548	1-136-177-00	MYLAR	1µF 5% 50V	CN503	* 1-564-513-11	PLUG, CONNECTOR	10P
C1549	1-130-471-00	MYLAR	0.001µF 5% 50V	CN504	* 1-580-689-11	PIN, CONNECTOR (PC BOARD)	4P
C1550	1-104-665-11	ELECT	100µF 20% 25V	CN505	* 1-580-689-11	PIN, CONNECTOR (PC BOARD)	4P
C1551	1-102-121-00	CERAMIC	0.0022µF 10% 50V	CN506	* 1-580-689-11	PIN, CONNECTOR (PC BOARD)	4P
C1552	1-106-220-00	MYLAR	0.1µF 10% 100V	CN507	* 1-691-134-11	PIN, CONNECTOR (PC BOARD)	2P
C1555	1-104-665-11	ELECT	100µF 20% 25V	CN508	1-695-915-11	TAB (CONTACT)	
C1556	1-104-665-11	ELECT	100µF 20% 25V	CN605	* 1-779-890-11	CONNECTOR, BOARD TO BOARD	10P
C1557	1-126-969-11	ELECT	220µF 20% 50V	CN651	* 1-779-890-11	CONNECTOR, BOARD TO BOARD	10P
C1559	1-137-401-11	MYLAR	0.22µF 10% 100V	CN652	* 1-573-963-11	PIN, CONNECTOR (PC BOARD)	3P
C1560	1-126-942-61	ELECT	1000µF 20% 25V	CN653	1-695-915-11	TAB (CONTACT)	
C1561	1-102-121-00	CERAMIC	0.0022µF 10% 50V	CN1501	* 1-564-507-11	PLUG, CONNECTOR	4P
C1562	1-102-125-00	CERAMIC	0.0047µF 10% 50V	CN1502	* 1-779-890-11	CONNECTOR, BOARD TO BOARD	10P
C1563	1-137-370-11	MYLAR	0.01µF 5% 50V	CN1503	* 1-564-507-11	PLUG, CONNECTOR	4P
C1566	1-137-370-11	MYLAR	0.01µF 5% 50V	CN1504	* 1-564-507-11	PLUG, CONNECTOR	4P
C1570	1-130-471-00	MYLAR	0.001µF 5% 50V	CN1505	* 1-564-507-11	PLUG, CONNECTOR	4P
C1571	1-102-074-00	CERAMIC	0.001µF 10% 50V	CN1506	* 1-564-506-11	PLUG, CONNECTOR	3P
C1572	1-102-074-00	CERAMIC	0.001µF 10% 50V	CN1507	* 1-564-506-11	PLUG, CONNECTOR	3P
C6501	1-126-964-11	ELECT	10µF 20% 50V	CN1508	* 1-564-506-11	PLUG, CONNECTOR	3P
C6502	1-126-961-11	ELECT	2.2µF 20% 50V	CN6501	* 1-691-291-11	PIN, CONNECTOR (PC BOARD)	5P
C6503	1-130-467-00	MYLAR	470pF 5% 50V	CN6502	* 1-691-960-11	PIN, CONNECTOR (PC BOARD)	3P
C6504	1-130-467-00	MYLAR	470pF 5% 50V	<DIODE>			
C6505	1-126-963-11	ELECT	4.7µF 20% 50V	D501	8-719-109-85	DIODE	RD5.1ESB2
C6506	1-104-330-91	CERAMIC	470pF 10% 1KV	D505	8-719-110-41	DIODE	RD15ESB2
C6507	1-104-330-91	CERAMIC	470pF 10% 1KV	D506	8-719-921-63	DIODE	MTZJ-7.5B
C6508	1-130-029-00	FILM	0.0082µF 5% 50V	D507	8-719-991-33	DIODE	1SS133T-77
C6509	1-136-165-00	MYLAR	0.1µF 5% 50V	D513	8-719-991-33	DIODE	1SS133T-77
C6510	1-107-824-11	CERAMIC	220pF 5% 1KV	D517	8-719-979-85	DIODE	EGP20G
C6511	1-126-964-11	ELECT	10µF 20% 50V	D518	8-719-945-80	DIODE	ERC06-15S
C6513	1-102-129-00	CERAMIC	0.01µF 10% 50V	D520	8-719-302-43	DIODE	EL1Z
C6514	1-115-389-11	FILM	0.018µF 3% 800V	D522	△ 8-719-302-43	DIODE	EL1Z
C6515	1-115-389-11	FILM	0.018µF 3% 800V	D525	8-719-018-82	DIODE	RGPO2-20EL-6394
C6516	1-113-611-11	ELECT(BLOCK)	820µF 20% 250V	D526	8-719-018-82	DIODE	RGPO2-20EL-6394
C6517	1-113-611-11	ELECT(BLOCK)	820µF 20% 250V	D528	8-719-908-03	DIODE	GP08D
C6518	1-126-961-11	ELECT	2.2µF 20% 50V	D529	8-719-302-43	DIODE	EL1Z
C6519	1-126-964-11	ELECT	10µF 20% 50V	D530	8-719-991-33	DIODE	1SS133T-77
C6520	1-102-106-00	CERAMIC	100pF 10% 50V	D531	8-719-991-33	DIODE	1SS133T-77
C6521	1-102-106-00	CERAMIC	100pF 10% 50V	D532	8-719-908-03	DIODE	GP08D
C6522	1-102-074-00	CERAMIC	0.001µF 10% 50V	D533	8-719-302-43	DIODE	EL1Z
C6523	1-102-129-00	CERAMIC	0.01µF 10% 50V	D534	8-719-302-43	DIODE	EL1Z
C6524	1-102-106-00	CERAMIC	100pF 10% 50V				
C6525	1-102-106-00	CERAMIC	100pF 10% 50V				
C6527	1-102-106-00	CERAMIC	100pF 10% 50V				
C6528	1-107-679-91	ELECT	10µF 20% 450V				

The components identified by shading and mark Δ are critical for safety.
Replace only with part number specified.



REF. NO.	PART NO.	DESCRIPTION	REMARK	REF. NO.	PART NO.	DESCRIPTION	REMARK
D650	8-719-028-45	DIODE D2L20U		D6524	8-719-110-41	DIODE RD15ESB2	
D652	8-719-028-45	DIODE D2L20U		D6525	8-719-991-33	DIODE 1SS133T-77	
D653	8-719-028-45	DIODE D2L20U		D6526	8-719-110-49	DIODE RD18ESB2	
D654	8-719-057-96	DIODE D10SC6M-4012		D6527	8-719-510-48	DIODE D1N20R	
D655	8-719-052-91	DIODE D4SBS4-F		D6529	8-719-063-70	DIODE D1NL20U	
D656	8-719-028-45	DIODE D2L20U		D6530	8-719-063-70	DIODE D1NL20U	
D657	8-719-028-45	DIODE D2L20U		D6531	8-719-991-33	DIODE 1SS133T-77	
D659	8-719-063-70	DIODE D1NL20U		D6532	8-719-991-33	DIODE 1SS133T-77	
D660	8-719-028-45	DIODE D2L20U				<FUSE>	
D661	8-719-991-33	DIODE 1SS133T-77		F651	Δ 1-576-360-21	FUSE, MULTIPLE	
D663	8-719-991-33	DIODE 1SS133T-77		F652	Δ 1-576-360-21	FUSE, MULTIPLE	
D667	8-719-032-12	DIODE D1NS6				<FERRITE BEAD>	
D670	8-719-027-22	DIODE D3S6M-F		FB651	1-410-396-41	FERRITE	0.45 μ H
D671	8-719-027-22	DIODE D3S6M-F		FB655	1-410-396-41	FERRITE	0.45 μ H
D672	8-719-200-82	DIODE 11ES2		FB656	1-410-396-41	FERRITE	0.45 μ H
D674	8-719-991-33	DIODE 1SS133T-77		FB6501	1-410-397-21	FERRITE	1.1 μ H
D675	8-719-110-17	DIODE RD10ESB2				<IC>	
D677	8-719-991-33	DIODE 1SS133T-77		IC502	8-759-133-90	IC μ PC339C	
D1501	8-719-109-89	DIODE RD5.6ESB2		IC651	8-759-103-93	IC μ PC393C	
D1503	8-719-921-40	DIODE MTZJ-4.7C		IC652	8-759-701-84	IC NJM7905FA	
D1504	8-719-110-08	DIODE RD8.2ESB2		IC653	8-759-701-75	IC NJM7805FA	
D1505	8-719-110-41	DIODE RD15ESB2		IC654	Δ 8-749-012-13	IC DM-58	
D1506	8-719-110-41	DIODE RD15ESB2		IC655	8-759-450-47	IC BA05T	
D1507	8-719-110-41	DIODE RD15ESB2		IC1501	8-752-068-36	IC CXA1726AS	
D1509	8-719-110-41	DIODE RD15ESB2		IC1502	8-749-014-37	IC STK392-150	
D1510	8-719-110-41	DIODE RD15ESB2		IC1504	8-759-634-51	IC M5218AP	
D1513	8-719-110-41	DIODE RD15ESB2		IC1505	8-759-634-51	IC M5218AP	
D1515	8-719-110-41	DIODE RD15ESB2		IC1506	8-749-014-37	IC STK392-150	
D1520	8-719-109-93	DIODE RD6.2ESB2		IC1507	8-759-634-51	IC M5218AP	
D1521	8-719-109-93	DIODE RD6.2ESB2		IC1509	8-759-593-33	IC LA78045	
D1522	8-719-924-16	DIODE MTZJ-T-77-24		IC6501	8-749-013-78	IC MCR5102	
D1523	8-719-924-16	DIODE MTZJ-T-77-24		IC6502	8-759-133-90	IC μ PC339C	
D1525	8-719-908-03	DIODE GP08D		IC6503	8-759-198-31	IC μ PC1093J-1-T	
D6501	8-719-979-58	DIODE EGP10D				<COIL>	
D6502	8-719-510-02	DIODE D1NS4		L501	1-412-533-21	INDUCTOR	47 μ H
D6503	8-719-921-88	DIODE MTZJ-13B		L502	1-414-187-11	INDUCTOR	47 μ H
D6504	8-719-979-64	DIODE μ F4005PKG23		L503	1-459-104-00	COIL, DUST CORE	
D6505	8-719-052-90	DIODE D1NL40-TA2		L504	Δ 1-419-082-11	COIL, HORIZONTAL LINEARITY	
D6506	8-719-052-90	DIODE D1NL40-TA2		L505	1-412-552-11	INDUCTOR	2.2mH
D6507	8-719-110-31	DIODE RD12ESB2		L651	1-419-389-21	INDUCTOR	8.2 μ H
D6508	8-719-991-33	DIODE 1SS133T-77		L652	1-419-389-21	INDUCTOR	8.2 μ H
D6509	8-719-991-33	DIODE 1SS133T-77		L653	1-406-975-21	INDUCTOR	47 μ H
D6510	8-719-991-33	DIODE 1SS133T-77		L654	1-410-396-41	FERRITE	0.45 μ H
D6511	8-719-991-33	DIODE 1SS133T-77		L655	1-410-396-41	FERRITE	0.45 μ H
D6512	8-719-991-33	DIODE 1SS133T-77		L656	1-412-525-31	INDUCTOR	10 μ H
D6513	8-719-991-33	DIODE 1SS133T-77		L657	1-412-525-31	INDUCTOR	10 μ H
D6514	8-719-110-31	DIODE RD12ESB2		L658	1-412-525-31	INDUCTOR	10 μ H
D6515	8-719-991-33	DIODE 1SS133T-77		L659	1-412-521-31	INDUCTOR	4.7 μ H
D6516	8-719-991-33	DIODE 1SS133T-77					
D6517	8-719-991-33	DIODE 1SS133T-77					
D6518	8-719-991-33	DIODE 1SS133T-77					
D6519	8-719-991-33	DIODE 1SS133T-77					
D6520	8-719-991-33	DIODE 1SS133T-77					
D6521	8-719-068-00	DIODE ERC04-06SE					
D6522	8-719-068-00	DIODE ERC04-06SE					
D6523	8-719-948-45	DIODE ERA22-08					



• The components identified by in this manual have been carefully factory-selected for each set in order to satisfy regulations regarding X-ray radiation. Should replacement be required, replace only with the value originally used.

The components identified by shading and mark are critical for safety. Replace only with part number specified.

REF. NO.	PART NO.	DESCRIPTION	REMARK	REF. NO.	PART NO.	DESCRIPTION	REMARK
L660	1-412-521-31	INDUCTOR	4.7μH	Q6503	8-729-119-76	TRANSISTOR	2SA1175-HFE
L1501	1-412-533-21	INDUCTOR	47μH	Q6504	8-729-423-33	TRANSISTOR	2SC3311A-QRSTA
L1502	1-412-533-21	INDUCTOR	47μH	Q6505	8-729-423-33	TRANSISTOR	2SC3311A-QRSTA
L1509	1-412-533-21	INDUCTOR	47μH	Q6506	8-729-046-40	TRANSISTOR	2SK2663
L1510	1-412-533-21	INDUCTOR	47μH	Q6507	8-729-922-39	TRANSISTOR	2SD2144S-V
L1511	1-412-533-21	INDUCTOR	47μH	Q6508	8-729-119-76	TRANSISTOR	2SA1175-HFE
L1512	1-412-533-21	INDUCTOR	47μH	<RESISTOR>			
L1513	1-412-525-31	INDUCTOR	10μH	R501	1-247-843-11	CARBON	3.3K 5% 1/4W
L1514	1-412-911-11	FERRITE	0μH	R502	1-249-419-11	CARBON	1.5K 5% 1/4W
L1515	1-412-911-11	FERRITE	0μH	R503	1-260-336-11	CARBON	4.7K 5% 1/2W
<NEON LAMP>				R504	1-260-087-11	CARBON	100 5% 1/2W
NL501	1-517-778-21	LAMP, NEON		R505	1-260-087-11	CARBON	100 5% 1/2W
NL502	1-517-778-21	LAMP, NEON		R506	1-216-481-11	METAL OXIDE	1.2K 5% 3W F
NL503	1-517-778-21	LAMP, NEON		R507	1-216-481-11	METAL OXIDE	1.2K 5% 3W F
NL504	1-517-778-21	LAMP, NEON		R508	1-216-481-11	METAL OXIDE	1.2K 5% 3W F
NL505	1-517-778-21	LAMP, NEON		R509	1-260-337-11	CARBON	5.6K 5% 1/2W
<PHOTO COUPLER>				R510	1-249-421-11	CARBON	2.2K 5% 1/4W
PH6501	8-749-924-35	PHOTO COUPLER ON3171-R		R511	1-215-879-11	METAL OXIDE	47K 5% 1W F
PH6502	8-749-924-35	PHOTO COUPLER ON3171-R		R512	1-249-422-11	CARBON	2.7K 5% 1/4W
<IC LINK>				R513	1-249-422-11	CARBON	2.7K 5% 1/4W
PS501	1-533-593-11	LINK, IC		R514	1-249-422-11	CARBON	2.7K 5% 1/4W
PS653	1-533-593-11	LINK, IC		R515	1-260-131-11	CARBON	470K 5% 1/2W
PS1501	1-533-593-11	LINK, IC		R517	1-247-891-00	CARBON	330K 5% 1/4W
PS1502	1-533-593-11	LINK, IC		R519	1-215-445-00	METAL	10K 1% 1/4W
PS1503	1-533-593-11	LINK, IC		R522	1-215-399-00	METAL	120 1% 1/4W
PS1504	1-533-593-11	LINK, IC		R523	1-247-895-91	CARBON	470K 5% 1/4W
PS1505	1-533-593-11	LINK, IC		R524	1-247-863-91	CARBON	22K 5% 1/4W
PS1506	1-533-593-11	LINK, IC		R525	1-249-428-11	CARBON	8.2K 5% 1/4W
<TRANSISTOR>				R526	1-249-437-11	CARBON	47K 5% 1/4W
Q501	8-729-048-47	TRANSISTOR	2SC2688(5)-LK	R527	1-249-428-11	CARBON	8.2K 5% 1/4W
Q502	8-729-048-46	TRANSISTOR	2SD2578-RF	R528	1-249-437-11	CARBON	47K 5% 1/4W
Q503	8-729-931-45	TRANSISTOR	IRF614	R529	1-249-439-11	CARBON	68K 5% 1/4W
Q505	8-729-032-61	TRANSISTOR	2SC5022-02	R530	1-249-428-11	CARBON	8.2K 5% 1/4W
Q506	8-729-119-76	TRANSISTOR	2SA1175-HFE	R531	1-249-429-11	CARBON	10K 5% 1/4W
Q507	8-729-032-61	TRANSISTOR	2SC5022-02	R532	1-249-430-11	CARBON	12K 5% 1/4W
Q652	8-729-922-39	TRANSISTOR	2SD2144S-V	R535	1-247-887-00	CARBON	220K 5% 1/4W
Q654	8-729-119-76	TRANSISTOR	2SA1175-HFE	R536		METAL	1/4W
Q655	8-729-423-33	TRANSISTOR	2SC3311A-QRSTA	R537	1-247-863-91	CARBON	22K 5% 1/4W
Q1501	8-729-423-33	TRANSISTOR	2SC3311A-QRSTA	R538	1-215-443-00	METAL	8.2K 1% 1/4W
Q1502	8-729-119-76	TRANSISTOR	2SA1175-HFE	R542	1-249-424-11	CARBON	3.9K 5% 1/4W
Q1503	8-729-423-33	TRANSISTOR	2SC3311A-QRSTA	R543	1-260-135-11	CARBON	1M 5% 1/2W
Q1505	8-729-423-33	TRANSISTOR	2SC3311A-QRSTA	R544	1-249-405-11	CARBON	100 5% 1/4W F
Q1506	8-729-423-33	TRANSISTOR	2SC3311A-QRSTA	R545		METAL	1/4W
Q1508	8-729-423-33	TRANSISTOR	2SC3311A-QRSTA	R546	1-215-456-00	METAL	30K 1% 1/4W
Q1509	8-729-119-76	TRANSISTOR	2SA1175-HFE	R548	1-215-449-00	METAL	15K 1% 1/4W
Q1511	8-729-423-33	TRANSISTOR	2SC3311A-QRSTA	R550	1-215-910-00	METAL OXIDE	68 5% 3W F
Q6501	8-729-140-93	TRANSISTOR	2SB733-34	R551	1-215-910-00	METAL OXIDE	68 5% 3W F
Q6502	8-729-119-76	TRANSISTOR	2SA1175-HFE	R556	1-249-437-11	CARBON	47K 5% 1/4W
				R563	1-247-887-00	CARBON	220K 5% 1/4W
				R566	1-215-868-00	METAL OXIDE	680 5% 1W F
				R567	1-249-437-11	CARBON	47K 5% 1/4W
				R568	1-249-405-11	CARBON	100 5% 1/4W F
				R569	1-260-314-11	CARBON	68 5% 1/2W
				R570	1-247-807-31	CARBON	100 5% 1/4W



REF. NO.	PART NO.	DESCRIPTION	REMARK	REF. NO.	PART NO.	DESCRIPTION	REMARK
R571	1-215-917-11	METAL OXIDE	1K 5% 3W F	R1501	1-214-800-11	METAL	2.2 1% 1/2W
R572	1-216-490-11	METAL OXIDE	39K 5% 3W F	R1502	1-214-800-11	METAL	2.2 1% 1/2W
R573	1-214-912-00	METAL	91K 1% 1/2W	R1503	1-215-421-00	METAL	1K 1% 1/4W
R574	1-216-490-11	METAL OXIDE	39K 5% 3W F	R1504	1-215-433-00	METAL	3.3K 1% 1/4W
R575	1-247-863-91	CARBON	22K 5% 1/4W	R1505	1-247-815-91	CARBON	220 5% 1/4W
R576	1-247-881-00	CARBON	120K 5% 1/4W	R1506	1-247-815-91	CARBON	220 5% 1/4W
R577	1-214-923-00	METAL	270K 1% 1/2W	R1507	1-215-433-00	METAL	3.3K 1% 1/4W
R578	1-216-490-11	METAL OXIDE	39K 5% 3W F	R1508	1-215-421-00	METAL	1K 1% 1/4W
R579	1-216-490-11	METAL OXIDE	39K 5% 3W F	R1509	1-214-800-11	METAL	2.2 1% 1/2W
R580	1-249-413-11	CARBON	470 5% 1/4W	R1510	1-214-800-11	METAL	2.2 1% 1/2W
R581	1-247-807-31	CARBON	100 5% 1/4W	R1511	1-214-800-11	METAL	2.2 1% 1/2W
R582	1-260-292-11	CARBON	1 5% 1/2W	R1512	1-214-800-11	METAL	2.2 1% 1/2W
R583	1-260-117-11	CARBON	33K 5% 1/2W	R1513	1-215-421-00	METAL	1K 1% 1/4W
R584	1-249-377-11	CARBON	0.47 5% 1/4W F	R1514	1-215-433-00	METAL	3.3K 1% 1/4W
R586	1-215-863-11	METAL OXIDE	100 5% 1W F (43T75A)	R1515	1-247-815-91	CARBON	220 5% 1/4W
R586	1-215-864-00	METAL OXIDE	150 5% 1W F (53SV75A)	R1516	1-249-429-11	CARBON	10K 5% 1/4W
R587	1-216-349-00	METAL OXIDE	1 5% 1W F	R1517	1-247-887-00	CARBON	220K 5% 1/4W
R588	1-215-863-11	METAL OXIDE	100 5% 1W F (43T75A)	R1518	1-249-429-11	CARBON	10K 5% 1/4W
R588	1-215-864-00	METAL OXIDE	150 5% 1W F (53SV75A)	R1519	1-249-437-11	CARBON	47K 5% 1/4W
R589	1-247-807-31	CARBON	100 5% 1/4W	R1520	1-247-881-00	CARBON	120K 5% 1/4W
R590	1-260-127-11	CARBON	220K 5% 1/2W	R1521	1-215-474-00	METAL	160K 1% 1/4W
R591	1-216-392-11	METAL OXIDE	1.8 5% 3W F	R1522	1-214-800-11	METAL	2.2 1% 1/2W
R592	1-247-863-91	CARBON	22K 5% 1/4W	R1523	1-214-800-11	METAL	2.2 1% 1/2W
R593	1-249-429-11	CARBON	10K 5% 1/4W	R1524	1-215-421-00	METAL	1K 1% 1/4W
R594	1-249-377-11	CARBON	0.47 5% 1/4W F	R1525	1-215-433-00	METAL	3.3K 1% 1/4W
R595	1-249-377-11	CARBON	0.47 5% 1/4W F	R1526	1-247-815-91	CARBON	220 5% 1/4W
R596	1-249-377-11	CARBON	0.47 5% 1/4W F	R1527	1-247-815-91	CARBON	220 5% 1/4W
R597	1-260-288-11	CARBON	0.47 5% 1/2W	R1528	1-215-433-00	METAL	3.3K 1% 1/4W
R598	1-249-377-11	CARBON	0.47 5% 1/4W F	R1529	1-215-421-00	METAL	1K 1% 1/4W
R599	1-249-429-11	CARBON	10K 5% 1/4W	R1530	1-214-800-11	METAL	2.2 1% 1/2W
R600	1-247-863-91	CARBON	22K 5% 1/4W	R1531	1-214-800-11	METAL	2.2 1% 1/2W
R652	1-249-377-11	CARBON	0.47 5% 1/4W F	R1532	1-214-800-11	METAL	2.2 1% 1/2W
R654	1-216-365-00	METAL OXIDE	0.47 5% 2W F	R1533	1-249-441-11	CARBON	100K 5% 1/4W
R655	1-249-417-11	CARBON	1K 5% 1/4W	R1534	1-214-800-11	METAL	2.2 1% 1/2W
R656	1-249-377-11	CARBON	0.47 5% 1/4W F	R1535	1-215-421-00	METAL	1K 1% 1/4W
R657	1-215-421-00	METAL	1K 1% 1/4W	R1536	1-215-433-00	METAL	3.3K 1% 1/4W
R659	1-215-446-00	METAL	11K 1% 1/4W	R1537	1-247-815-91	CARBON	220 5% 1/4W
R660	1-215-441-00	METAL	6.8K 1% 1/4W	R1538	1-249-429-11	CARBON	10K 5% 1/4W
R661	1-215-483-00	METAL	390K 1% 1/4W	R1539	1-249-428-11	CARBON	8.2K 5% 1/4W
R662	1-215-445-00	METAL	10K 1% 1/4W	R1540	1-249-417-11	CARBON	1K 5% 1/4W
R663	1-215-445-00	METAL	10K 1% 1/4W	R1541	1-247-843-11	CARBON	3.3K 5% 1/4W
R664	1-249-425-11	CARBON	4.7K 5% 1/4W	R1542	1-249-429-11	CARBON	10K 5% 1/4W
R665	1-249-425-11	CARBON	4.7K 5% 1/4W	R1543	1-249-429-11	CARBON	10K 5% 1/4W
R666	1-249-429-11	CARBON	10K 5% 1/4W	R1544	1-249-419-11	CARBON	1.5K 5% 1/4W
R667	1-249-425-11	CARBON	4.7K 5% 1/4W	R1548	1-249-438-11	CARBON	56K 5% 1/4W
R668	1-249-417-11	CARBON	1K 5% 1/4W	R1549	1-214-800-11	METAL	2.2 1% 1/2W
R671	1-249-429-11	CARBON	10K 5% 1/4W	R1550	1-215-447-00	METAL	12K 1% 1/4W
R672	1-249-417-11	CARBON	1K 5% 1/4W F	R1551	1-249-428-11	CARBON	8.2K 5% 1/4W
R673	1-249-425-11	CARBON	4.7K 5% 1/4W	R1552	1-214-800-11	METAL	2.2 1% 1/2W
R675	1-249-429-11	CARBON	10K 5% 1/4W	R1554	1-215-449-00	METAL	15K 1% 1/4W
R677	1-249-417-11	CARBON	1K 5% 1/4W	R1555	1-247-807-31	CARBON	100 5% 1/4W
R678	1-249-425-11	CARBON	4.7K 5% 1/4W	R1556	1-247-863-91	CARBON	22K 5% 1/4W
				R1557	1-249-429-11	CARBON	10K 5% 1/4W
				R1558	1-249-429-11	CARBON	10K 5% 1/4W
				R1559	1-215-857-11	METAL OXIDE	10 5% 1W F
				R1560	1-216-452-11	METAL OXIDE	180 5% 2W F



REF. NO.	PART NO.	DESCRIPTION	REMARK	REF. NO.	PART NO.	DESCRIPTION	REMARK
R1561	1-249-429-11	CARBON	10K 5% 1/4W	R6514	1-202-933-61	FUSIBLE	0.1 10% 1/2W F
R1562	1-249-429-11	CARBON	10K 5% 1/4W	R6515	1-260-131-11	CARBON	470K 5% 1/2W
R1563	1-249-429-11	CARBON	10K 5% 1/4W	R6516	1-260-131-11	CARBON	470K 5% 1/2W
R1564	1-215-445-00	METAL	10K 1% 1/4W	R6517	1-249-429-11	CARBON	10K 5% 1/4W
R1565	1-249-429-11	CARBON	10K 5% 1/4W	R6518	1-247-863-91	CARBON	22K 5% 1/4W
R1566	1-249-427-11	CARBON	6.8K 5% 1/4W	R6519	1-215-864-00	METAL OXIDE	150 5% 1W F
R1567	1-247-863-91	CARBON	22K 5% 1/4W	R6520	1-249-429-11	CARBON	10K 5% 1/4W
R1568	1-249-429-11	CARBON	10K 5% 1/4W	R6521	1-249-429-11	CARBON	10K 5% 1/4W
R1570	1-249-383-11	CARBON	1.5 5% 1/4W F	R6522	1-247-863-91	CARBON	22K 5% 1/4W
R1576	1-249-429-11	CARBON	10K 5% 1/4W	R6523	1-249-425-11	CARBON	4.7K 5% 1/4W
R1577	1-215-447-00	METAL	12K 1% 1/4W	R6524	1-249-425-11	CARBON	4.7K 5% 1/4W
R1578	1-249-429-11	CARBON	10K 5% 1/4W	R6525	1-249-429-11	CARBON	10K 5% 1/4W
R1579	1-215-421-00	METAL	1K 1% 1/4W	R6526	1-249-437-11	CARBON	47K 5% 1/4W
R1580	1-215-421-00	METAL	1K 1% 1/4W	R6527	1-215-489-00	METAL	680K 1% 1/4W
R1581	1-215-474-00	METAL	160K 1% 1/4W	R6528	1-215-489-00	METAL	680K 1% 1/4W
R1582	1-249-421-11	CARBON	2.2K 5% 1/4W	R6529	1-215-489-00	METAL	680K 1% 1/4W
R1583	1-247-807-31	CARBON	100 5% 1/4W	R6530	1-215-489-00	METAL	680K 1% 1/4W
R1584	1-247-863-91	CARBON	22K 5% 1/4W	R6531	1-215-489-00	METAL	680K 1% 1/4W
R1585	1-215-449-00	METAL	15K 1% 1/4W	R6532	1-215-489-00	METAL	680K 1% 1/4W
R1586	1-249-441-11	CARBON	100K 5% 1/4W	R6533	1-215-489-00	METAL	680K 1% 1/4W
R1587	1-249-414-11	CARBON	560 5% 1/4W	R6534	1-215-489-00	METAL	680K 1% 1/4W
R1588	1-249-414-11	CARBON	560 5% 1/4W	R6535	1-215-489-00	METAL	680K 1% 1/4W
R1589	1-249-414-11	CARBON	560 5% 1/4W	R6536	1-215-489-00	METAL	680K 1% 1/4W
R1590	1-249-414-11	CARBON	560 5% 1/4W	R6537	1-247-895-91	CARBON	470K 5% 1/4W
R1591	1-249-414-11	CARBON	560 5% 1/4W	R6538	1-215-489-00	METAL	680K 1% 1/4W
R1592	1-249-414-11	CARBON	560 5% 1/4W	R6539	1-215-489-00	METAL	680K 1% 1/4W
R1593	1-216-475-11	METAL OXIDE	120 5% 3W F	R6540	1-215-471-00	METAL	120K 1% 1/4W
R1594	1-216-475-11	METAL OXIDE	120 5% 3W F	R6541	1-215-466-00	METAL	75K 1% 1/4W
R1595	1-216-475-11	METAL OXIDE	120 5% 3W F	R6542	1-215-471-00	METAL	120K 1% 1/4W
R1596	1-216-475-11	METAL OXIDE	120 5% 3W F	R6543	1-215-466-00	METAL	75K 1% 1/4W
R1597	1-216-475-11	METAL OXIDE	120 5% 3W F	R6544	1-215-457-00	METAL	33K 1% 1/4W
R1598	1-216-475-11	METAL OXIDE	120 5% 3W F	R6545	1-215-466-00	METAL	75K 1% 1/4W
R1599	1-249-429-11	CARBON	10K 5% 1/4W	R6546	1-215-458-00	METAL	36K 1% 1/4W
R1600	1-247-807-31	CARBON	100 5% 1/4W	R6547	1-215-437-00	METAL	4.7K 1% 1/4W
R1601	1-249-437-11	CARBON	47K 5% 1/4W	R6548	1-249-429-11	CARBON	10K 5% 1/4W
R1602	1-247-807-31	CARBON	100 5% 1/4W	R6549	1-215-463-00	METAL	56K 1% 1/4W
R1603	1-249-418-11	CARBON	1.2K 5% 1/4W	R6550	1-215-465-00	METAL	68K 1% 1/4W
R1604	1-249-429-11	CARBON	10K 5% 1/4W	R6551	1-215-469-00	METAL	100K 1% 1/4W
R1609	1-215-445-00	METAL	10K 1% 1/4W	R6552	1-215-485-00	METAL	470K 1% 1/4W
R1610	1-247-807-31	CARBON	100 5% 1/4W	R6553	1-215-473-00	METAL	150K 1% 1/4W
R1611	1-247-807-31	CARBON	100 5% 1/4W	R6554	1-215-469-00	METAL	100K 1% 1/4W
R1612	1-249-429-11	CARBON	10K 5% 1/4W	R6555	1-215-483-00	METAL	390K 1% 1/4W
R1613	1-249-429-11	CARBON	10K 5% 1/4W	R6556	1-215-445-00	METAL	10K 1% 1/4W
R1615	1-215-445-00	METAL	10K 1% 1/4W	R6557	1-215-469-00	METAL	100K 1% 1/4W
R6501	1-215-432-00	METAL	3K 1% 1/4W	R6558	1-215-469-00	METAL	100K 1% 1/4W
R6502	1-249-401-11	CARBON	47 5% 1/4W F	R6559	1-215-445-00	METAL	10K 1% 1/4W
R6503	1-219-512-11	CARBON	2.2M 5% 1/2W	R6561	1-249-413-11	CARBON	470 5% 1/4W
R6504	1-216-381-11	METAL OXIDE	0.22 5% 3W F	R6562	1-249-421-11	CARBON	2.2K 5% 1/4W
R6505	1-216-381-11	METAL OXIDE	0.22 5% 3W F	R6563	1-249-429-11	CARBON	10K 5% 1/4W
R6506	1-215-421-00	METAL	1K 1% 1/4W	R6564	1-215-857-11	METAL OXIDE	10 5% 1W F
R6507	1-219-512-11	CARBON	2.2M 5% 1/2W	R6565	1-249-389-11	CARBON	4.7 5% 1/4W F
R6508	1-215-481-00	METAL	330K 1% 1/4W	R6566	1-215-493-00	METAL	1M 1% 1/4W
R6509	1-215-481-00	METAL	330K 1% 1/4W	R6567	1-240-205-91	CARBON	22M 5% 1/2W
R6510	1-215-421-00	METAL	1K 1% 1/4W	R6568	1-249-421-11	CARBON	2.2K 5% 1/4W
R6511	1-215-448-00	METAL	13K 1% 1/4W	R6569	1-247-791-91	CARBON	22 5% 1/4W
R6512	1-215-481-00	METAL	330K 1% 1/4W	R6570	1-249-441-11	CARBON	100K 5% 1/4W

The components identified by shading and mark Δ are critical for safety. Replace only with part number specified.



REF. NO.	PART NO.	DESCRIPTION	REMARK	REF. NO.	PART NO.	DESCRIPTION	REMARK
R6571	1-249-437-11	CARBON	47K 5% 1/4W	CN702 *	1-564-512-11	PLUG, CONNECTOR 9P	
R6572	1-249-413-11	CARBON	470 5% 1/4W	CN703	1-785-879-11	CONNECTOR, ONE TOUCH	
R6573	1-249-415-11	CARBON	680 5% 1/4W	CN704 Δ	1-251-182-11	SOCKET, CRT	
R6574	1-260-298-51	CARBON	3.3 5% 1/2W	CN705	1-695-915-11	TAB (CONTACT)	
R6575	1-249-429-11	CARBON	10K 5% 1/4W	CN706	1-695-915-11	TAB (CONTACT)	
R6576	1-249-439-11	CARBON	68K 5% 1/4W				
R6577	1-215-857-11	METAL OXIDE	10 5% 1W			<DIODE>	
R6580	1-249-429-11	CARBON	10K 5% 1/4W	D705	8-719-991-33	DIODE 1SS133T-77	
		<RELAY>		D706	8-719-991-33	DIODE 1SS133T-77	
RY6501	1-515-999-11	RELAY, POWER		D707	8-719-991-33	DIODE 1SS133T-77	
RY6502	1-515-999-11	RELAY, POWER		D708	8-719-991-33	DIODE 1SS133T-77	
		<SPARK GAP>		D709	8-719-991-33	DIODE 1SS133T-77	
SG501	1-519-466-11	GAP, SPARK				<COIL>	
SG502	1-519-466-11	GAP, SPARK		L701	1-414-188-41	INDUCTOR 68 μ H	
		<TRANSFORMER>		L702	1-412-911-11	FERRITE 0 μ H	
T501 Δ	1-433-836-11	TRANSFORMER, HORIZONTAL DRIVE				<NEON LAMP>	
T502 Δ	1-433-876-11	TRANSFORMER, FERRITE (PMT)		NL701	1-517-778-21	LAMP, NEON	
T504 Δ	1-453-238-21	FBT ASSY				<TRANSISTOR>	
T6501	1-433-871-11	TRANSFORMER, CONVERTER (PIT)		Q704	8-729-423-33	TRANSISTOR 2SC3311A-QRSTA	
T6502	1-433-844-11	TRANSFORMER, CONVERTER		Q705	8-729-326-11	TRANSISTOR 2SC2611	
		<THERMISTOR>		Q706	8-729-200-17	TRANSISTOR 2SA1091-O	
TH1501	1-807-925-11	THERMISTOR				<RESISTOR>	
TH6501	1-803-586-11	THERMISTOR, NTC		R701	1-219-743-11	CARBON 100 5% 1/2W	
		<TEST PIN>		R702	1-260-132-11	CARBON 560K 5% 1/2W	
TP501 *	1-535-881-21	TERMINAL, TP (AUTO INSERTION)		R703	1-216-486-00	METAL OXIDE 8.2K 5% 3W	

	* A-1331-922-A	CR BOARD, COMPLETE		R704	1-215-476-00	METAL 200K 1% 1/4W	
		*****		R711	1-247-807-31	CARBON 100 5% 1/4W	
	4-382-854-11	SCREW(M3X10), P, SW (+)		R712	1-249-404-00	CARBON 82 5% 1/4W	
		<CAPACITOR>		R713	1-216-486-00	METAL OXIDE 8.2K 5% 3W	
C701	1-104-570-11	CERAMIC 0.001 μ F	10% 2KV	R714	1-249-393-11	CARBON 10 5% 1/4W	
C703	1-104-664-11	ELECT 47 μ F	20% 25V	R715	1-249-419-11	CARBON 1.5K 5% 1/4W	
C706	1-102-114-00	CERAMIC 470pF	10% 50V	R718	1-260-133-11	CARBON 680K 5% 1/2W	
C708	1-102-113-00	CERAMIC 390pF	10% 50V			<SPARK GAP>	
C709	1-101-880-00	CERAMIC 47pF	5% 50V	R719	1-249-425-11	CARBON 4.7K 5% 1/4W	
C710	1-162-115-00	CERAMIC 330pF	10% 2KV	R720	1-260-099-11	CARBON 1K 5% 1/2W	
C711	1-161-830-00	CERAMIC 0.0047 μ F	500V	R721	1-260-099-11	CARBON 1K 5% 1/2W	
C712	1-107-662-11	ELECT 22 μ F	20% 250V	R722	1-260-087-11	CARBON 100 5% 1/2W	
		<CONNECTOR>		R723	1-412-911-11	FERRITE 0 μ H	
CN701 *	1-564-507-11	PLUG, CONNECTOR 4P				<TEST PIN>	
				SG701	1-519-422-11	GAP, SPARK	
				SG702	1-517-729-31	GAP, SPARK	
						<TEST PIN>	
				TP701 *	1-535-881-21	TERMINAL, TP (AUTO INSERTION)	



The components identified by shading and mark Δ are critical for safety. Replace only with part number specified.

REF. NO.	PART NO.	DESCRIPTION	REMARK	REF. NO.	PART NO.	DESCRIPTION	REMARK
	* A-1331-923-A	CG BOARD, COMPLETE		L732	1-412-911-11	FERRITE	0 μ H
		*****		L1301	1-412-911-11	FERRITE	0 μ H
				L1302	1-412-911-11	FERRITE	0 μ H
	4-382-854-11	SCREW(M3X10), P, SW (+)				<NEON LAMP>	
		<CAPACITOR>		NL731	1-517-778-21	LAMP, NEON	
C731	1-104-664-11	ELECT	47 μ F 20% 25V			<TRANSISTOR>	
C732	1-104-570-11	CERAMIC	0.001 μ F 10% 2KV				
C733	1-102-114-00	CERAMIC	470pF 10% 50V				
C734	1-102-114-00	CERAMIC	470pF 10% 50V				
C735	1-101-880-00	CERAMIC	47pF 5% 50V				
C736	1-161-830-00	CERAMIC	0.0047 μ F 500V				
C737	1-162-115-00	CERAMIC	330pF 10% 2KV				
C738	1-107-662-11	ELECT	22 μ F 20% 250V				
C1301	1-106-343-00	MYLAR	0.001 μ F 10% 200V				
C1302	1-107-639-11	ELECT	47 μ F 20% 160V				
C1303	1-126-933-11	ELECT	100 μ F 20% 16V				
C1305	1-126-933-11	ELECT	100 μ F 20% 16V				
C1308	1-106-383-00	MYLAR	0.047 μ F 10% 200V				
C1309	1-106-383-00	MYLAR	0.047 μ F 10% 200V				
C1310	1-126-960-11	ELECT	1 μ F 20% 50V				
C1312	1-161-830-00	CERAMIC	0.0047 μ F 500V			<RESISTOR>	
C1313	1-102-129-00	CERAMIC	0.01 μ F 10% 50V	R731	1-219-743-11	CARBON	100 5% 1/2W
C1314	1-102-129-00	CERAMIC	0.01 μ F 10% 50V	R732	1-260-132-11	CARBON	560K 5% 1/2W
C1315	1-126-933-11	ELECT	100 μ F 20% 16V	R733	1-247-807-31	CARBON	100 5% 1/4W
		<CONNECTOR>		R734	1-260-087-11	CARBON	100 5% 1/2W
CN731	* 1-564-512-11	PLUG, CONNECTOR 9P		R735	1-249-403-11	CARBON	68 5% 1/4W
CN732	* 1-564-507-11	PLUG, CONNECTOR 4P		R736	1-216-486-00	METAL OXIDE	8.2K 5% 3W F
CN733	* 1-564-508-11	PLUG, CONNECTOR 5P		R737	1-249-393-11	CARBON	10 5% 1/4W
CN734	* 1-564-513-11	PLUG, CONNECTOR 10P		R738	1-249-414-11	CARBON	560 5% 1/4W
CN735	* 1-564-512-11	PLUG, CONNECTOR 9P		R739	1-216-486-00	METAL OXIDE	8.2K 5% 3W F
CN736	* 1-564-512-11	PLUG, CONNECTOR 9P		R741	1-249-425-11	CARBON	4.7K 5% 1/4W
CN737	1-785-879-11	CONNECTOR, ONE TOUCH		R742	1-260-099-11	CARBON	1K 5% 1/2W
CN738	1-695-915-11	TAB (CONTACT)		R743	1-247-881-00	CARBON	120K 1% 1/4W
CN739	1-695-915-11	TAB (CONTACT)		R744	1-260-133-11	CARBON	680K 5% 1/2W
CN740 Δ	1-251-182-11	SOCKET, CRT		R745	1-260-099-11	CARBON	1K 5% 1/2W
CN1301*	1-564-506-11	PLUG, CONNECTOR 3P		R746	1-249-437-11	CARBON	47K 5% 1/4W
CN1302*	1-564-506-11	PLUG, CONNECTOR 3P		R747	1-249-438-11	CARBON	56K 5% 1/4W
CN1303*	1-564-506-11	PLUG, CONNECTOR 3P		R753	1-412-911-11	FERRITE	0 μ H
CN1304*	1-564-509-11	PLUG, CONNECTOR 6P		R1301	1-215-916-00	METAL OXIDE	680 5% 3W F
		<DIODE>		R1302	1-215-916-00	METAL OXIDE	680 5% 3W F
D731	8-719-991-33	DIODE 1SS133T-77		R1303	1-249-400-11	CARBON	39 5% 1/4W F
D732	8-719-991-33	DIODE 1SS133T-77		R1304	1-249-391-11	CARBON	6.8 5% 1/4W F
D733	8-719-991-33	DIODE 1SS133T-77		R1305	1-249-391-11	CARBON	6.8 5% 1/4W F
D734	8-719-991-33	DIODE 1SS133T-77		R1306	1-249-429-11	CARBON	10K 5% 1/4W
D735	8-719-991-33	DIODE 1SS133T-77		R1307	1-260-311-11	CARBON	39 5% 1/2W
D736	8-719-109-84	DIODE RD5.1ESB1		R1308	1-249-419-11	CARBON	1.5K 5% 1/4W
D1304	8-719-991-33	DIODE 1SS133T-77		R1310	1-249-441-11	CARBON	100K 5% 1/4W
		<COIL>		R1311	1-249-419-11	CARBON	1.5K 5% 1/4W F
L731	1-414-188-41	INDUCTOR	68 μ H	R1314	1-249-419-11	CARBON	1.5K 5% 1/4W
				R1315	1-249-399-11	CARBON	33 5% 1/4W
				R1319	1-249-413-11	CARBON	470 5% 1/4W
				R1321	1-249-406-11	CARBON	120 5% 1/4W
				R1323	1-249-377-11	CARBON	0.47 5% 1/4W F
				R1324	1-249-425-11	CARBON	4.7K 5% 1/4W
				R1325	1-249-431-11	CARBON	15K 5% 1/4W

The components identified by shading and mark Δ are critical for safety. Replace only with part number specified.



REF. NO.	PART NO.	DESCRIPTION	REMARK	REF. NO.	PART NO.	DESCRIPTION	REMARK
R1327	1-249-441-11	CARBON	100K 5% 1/4W			<NEON LAMP>	
R1328	1-249-435-11	CARBON	33K 5% 1/4W	NL761	1-517-778-21	LAMP, NEON	
		<SPARK GAP>				<TRANSISTOR>	
SG731	1-519-422-11	GAP, SPARK		Q761	8-729-423-33	TRANSISTOR 2SC3311A-QRSTA	
SG732	1-517-729-31	GAP, SPARK		Q762	8-729-326-11	TRANSISTOR 2SC2611	
		<TEST PIN>		Q763	8-729-119-76	TRANSISTOR 2SA1175-HFE	
TP731	* 1-535-881-21	TERMINAL, TP (AUTO INSERTION)		Q764	8-729-200-17	TRANSISTOR 2SA1091-O	
TP732	* 1-535-881-21	TERMINAL, TP (AUTO INSERTION)				<RESISTOR>	
TP733	* 1-535-881-21	TERMINAL, TP (AUTO INSERTION)		R761	1-219-743-11	CARBON 100 5% 1/2W	
				R762	1-260-132-11	CARBON 560K 5% 1/2W	
				R763	1-247-807-31	CARBON 100 5% 1/4W	
				R764	1-216-486-00	METAL OXIDE 8.2K 5% 3W F	
				R765	1-247-807-31	CARBON 100 5% 1/4W	

	* A-1331-924-A	CB BOARD, COMPLETE		R766	1-216-486-00	METAL OXIDE 8.2K 5% 3W F	
		*****		R767	1-249-393-11	CARBON 10 5% 1/4W	
	4-382-854-11	SCREW(M3X10), P, SW (+)		R768	1-249-418-11	CARBON 1.2K 5% 1/4W	
				R770	1-249-404-00	CARBON 82 5% 1/4W	
				R771	1-249-426-11	CARBON 5.6K 5% 1/4W	
		<CAPACITOR>		R772	1-249-435-11	CARBON 33K 5% 1/4W	
C761	1-104-664-11	ELECT	47μF 20% 25V	R773	1-260-099-11	CARBON 1K 5% 1/2W	
C762	1-104-570-11	CERAMIC	0.001μF 10% 2KV	R775	1-249-425-11	CARBON 4.7K 5% 1/4W	
C763	1-102-114-00	CERAMIC	470pF 10% 50V	R776	1-260-133-11	CARBON 680K 5% 1/2W	
C764	1-102-112-00	CERAMIC	330pF 10% 50V	R777	1-260-099-11	CARBON 1K 5% 1/2W	
C765	1-101-880-00	CERAMIC	47pF 5% 50V	R778	1-259-880-11	CARBON 2.2M 5% 1/4W	
C767	1-162-115-00	CERAMIC	330pF 10% 2KV	R779	1-260-087-11	CARBON 100 5% 1/2W	
C768	1-126-964-11	ELECT	10μF 20% 50V	R783	1-412-911-11	FERRITE 0μH	
C769	1-161-830-00	CERAMIC	0.0047μF 500V			<SPARK GAP>	
C770	1-107-662-11	ELECT	22μF 20% 250V	SG761	1-519-422-11	GAP, SPARK	
				SG762	1-517-729-31	GAP, SPARK	
		<CONNECTOR>				<TEST PIN>	
CN761	* 1-564-508-11	PLUG, CONNECTOR 5P		TP761	* 1-535-881-21	TERMINAL, TP (AUTO INSERTION)	
CN762	* 1-564-512-11	PLUG, CONNECTOR 9P					
CN763	1-785-879-11	CONNECTOR, ONE TOUCH					
CN764	1-695-915-11	TAB (CONTACT)					
CN765	1-695-915-11	TAB (CONTACT)					
CN766 Δ	1-251-182-11	SOCKET, CRT					
		<DIODE>					
D761	8-719-991-33	DIODE	1SS133T-77			<CAPACITOR>	
D762	8-719-991-33	DIODE	1SS133T-77	C1291	1-126-791-11	ELECT 10μF 20% 16V	
D763	8-719-991-33	DIODE	1SS133T-77			<CONNECTOR>	
D764	8-719-991-33	DIODE	1SS133T-77				
D765	8-719-991-33	DIODE	1SS133T-77	CN1291*	1-564-518-11	PLUG, CONNECTOR 3P	
		<COIL>				<DIODE>	
L761	1-414-188-41	INDUCTOR	68μH	D1291	8-719-066-43	DIODE GP1U28Y	
L762	1-412-911-11	FERRITE	0μH				



REF. NO.	PART NO.	DESCRIPTION	REMARK
D1292	8-719-109-89	DIODE RD5.6ESB2	
D1293	8-719-109-89	DIODE RD5.6ESB2	
<RESISTOR>			
R1291	1-247-807-31	CARBON 100	5% 1/4W

* A-1372-762-A HA BOARD, COMPLETE *****			
<CONNECTOR>			
CN1202*	1-564-517-11	PLUG, CONNECTOR 2P	
CN1203*	1-564-522-11	PLUG, CONNECTOR 7P	
<DIODE>			
D1201	8-719-064-11	DIODE SPR-325MVW	
<RESISTOR>			
R1201	1-249-431-11	CARBON 15K	5% 1/4W
R1202	1-249-425-11	CARBON 4.7K	5% 1/4W
R1203	1-249-417-11	CARBON 1K	5% 1/4W
R1204	1-249-419-11	CARBON 1.5K	5% 1/4W
R1205	1-249-421-11	CARBON 2.2K	5% 1/4W
R1206	1-247-815-91	CARBON 220	5% 1/4W
<SWITCH>			
S1201	1-572-198-11	SWITCH, KEYBOARD (FLASH FOCUS)	
S1202	1-572-198-11	SWITCH, KEYBOARD (TV/VIDEO)	
S1203	1-572-198-11	SWITCH, KEYBOARD (VOLUME -)	
S1204	1-572-198-11	SWITCH, KEYBOARD (VOLUME +)	
S1205	1-572-198-11	SWITCH, KEYBOARD (CHANNEL -)	
S1206	1-572-198-11	SWITCH, KEYBOARD (CHANNEL +)	
S1207	1-572-198-11	SWITCH, KEYBOARD (POWER)	

* A-1372-620-A HB BOARD, COMPLETE *****			
<CAPACITOR>			
C1251	1-128-551-11	ELECT 22μF	20% 25V
C1252	1-128-551-11	ELECT 22μF	20% 25V
C1253	1-128-551-11	ELECT 22μF	20% 25V
C1254	1-128-551-11	ELECT 22μF	20% 25V
C1255	1-128-551-11	ELECT 22μF	20% 25V
<CONNECTOR>			
CN1252*	1-564-517-11	PLUG, CONNECTOR 2P	
CN1253*	1-564-526-11	PLUG, CONNECTOR 11P	

REF. NO.	PART NO.	DESCRIPTION	REMARK
<DIODE>			
D1251	8-719-110-17	DIODE RD10ESB2	
D1252	8-719-110-17	DIODE RD10ESB2	
D1253	8-719-110-17	DIODE RD10ESB2	
D1254	8-719-110-17	DIODE RD10ESB2	
D1255	8-719-110-17	DIODE RD10ESB2	
D1256	8-719-110-17	DIODE RD10ESB2	
<JACK>			
J1251	1-770-361-11	TERMINAL BLOCK, S	
<RESISTOR>			
R1251	1-249-429-11	CARBON 10K	5% 1/4W
R1252	1-249-424-11	CARBON 3.9K	5% 1/4W
R1253	1-249-421-11	CARBON 2.2K	5% 1/4W
R1254	1-249-418-11	CARBON 1.2K	5% 1/4W
R1255	1-249-425-11	CARBON 4.7K	5% 1/4W
R1256	1-247-804-11	CARBON 75	5% 1/4W
R1257	1-247-895-91	CARBON 470K	5% 1/4W
R1258	1-247-895-91	CARBON 470K	5% 1/4W
R1259	1-247-804-11	CARBON 75	5% 1/4W
R1260	1-247-804-11	CARBON 75	5% 1/4W
<SWITCH>			
S1251	1-572-198-11	SWITCH, KEYBOARD (SELECT)	
S1252	1-572-198-11	SWITCH, KEYBOARD (+)	
S1253	1-572-198-11	SWITCH, KEYBOARD (-)	
S1254	1-572-198-11	SWITCH, KEYBOARD (MENU)	
S1255	1-572-198-11	SWITCH, KEYBOARD (SET UP)	

* A-1390-933-A S BOARD, COMPLETE *****			
<CONNECTOR>			
CN3001*	1-564-506-11	PLUG, CONNECTOR 3P	
<DIODE>			
D3001	8-719-109-89	DIODE RD5.6ESB2	
<SWITCH>			
S3001	1-528-911-21	BATTERY, SOLAR	

The components identified by shading and mark Δ are critical for safety. Replace only with part number specified.

REF. NO.	PART NO.	DESCRIPTION	REMARK
		MISCELLANEOUS *****	
	Δ 1-223-925-11	RESISTOR ASSY (HIGH-VOLTAGE) (FOCUS PACK)	
	Δ 1-451-496-21	DEFLECTION YOKE	
	Δ 1-452-790-21	NECK ASSY	
	Δ 1-452-909-31	MAGNET ASSY, 4 POLE	
	1-529-396-11	SPEAKER (10cm) (43T75A)	
	1-529-644-11	SPEAKER (16cm) (53SV75A)	
	1-529-403-11	SPEAKER (6.6cm) (53SV75A)	
	1-556-945-21	CABLE, P-P	
	* 1-557-056-31	CABLE, P-P	
	Δ 1-783-838-11	CORD, POWER (WITH CONNECTOR)	
	Δ 8-598-414-20	CHANGER, ANTENNA	
	Δ 8-598-955-30	BLOCK ASSY, HIGH VOLTAGE	
	Δ 8-733-570-15	CRT 07MXC2(G)(HEATER)	
	Δ 8-733-571-15	CRT 07MXC2(R)(HEATER) (43T75A)	
	Δ 8-733-572-15	CRT 07MXC3(R)(HEATER) (53SV75A)	
	Δ 8-733-574-15	CRT 07MAC2(B)(HEATER) (43T75A)	
	Δ 8-733-575-15	CRT 07MAC3(B)(HEATER) (53SV75A)	

		ACCESSORIES AND PACKING MATERIALS *****	
	* 4-041-423-01	SHEET, PROTECTION (43T75A)	
	* 4-041-426-01	BAG, PROTECTION (53SV75A)	
	* 4-042-463-01	SHEET, PROTECTION (53SV75A)	
	* 4-049-155-01	BAG, PROTECTION (43T75A)	
	* 4-069-537-01	ASSY, CUSHION (UPPER) (43T75A)	
	* 4-069-538-01	ASSY, CUSHION (LOWER) (43T75A)	
	* 4-069-543-01	INDIVIDUAL CARTON (43T75A)	
	* 4-069-545-01	TRAY (43T75A)	
	* 4-069-573-01	INDIVIDUAL CARTON (53SV75A)	
	* 4-069-574-01	BOARD, BOTTOM (53SV75A)	
	* 4-069-575-01	TRAY (53SV75A)	
	* 4-069-576-01	CUSHION (UPPER) (ASSY) (53SV75A)	
	* 4-069-577-01	CUSHION (LOWER) (ASSY) (53SV75A)	
	4-076-754-11	MANUAL, INSTRUCTION	
		REMOTE COMMANDER *****	
	1-418-469-11	REMOTE COMMANDER (RM-Y906)	
	4-978-977-01	COVER, BATTERY (FOR RM-Y906)	

